



# ADAM TOOLS

# Adam

# Content

INTRODUCTION

**ADAM TOOLS** is an international professional enterprise which combines the designation and developing, manufacturing and processing, as well as marketing of hardware tools into one whole. Based on a scientific management system and a well-developed quality assurance system, we always aim at seeking for higher quality. Besides, the idea of advancement and uniqueness, and leading productive technology also guarantee our top quality. With people-oriented as our management concept, we provide for customers a well-developed after-sale service, both of which contributes to the acknowledgment of old and new customers to our products. The support from our customers also laid the foundation for our unshakable leading role in the global world of tools.

At present, **ADAM TOOLS** has been the largest professional tool manufacturer with the most complete range of species in the worldwide. Hence we obtain a great reputation and high praise in the global industry of tools. Forged by a large friction pressing machine with one-time molding, our products, especially the steel tools, **non-sparking tools** and Titanium tools, enjoy a world-class top quality. All of the tools are strictly in accordance with the DIN standard of German, ASME standard of United States and national GB standard of China. Under a perfect quality control system, our products have all been through a series of test from the material purchasing to end-product delivery, which ensures a 100% qualified rate before they are delivered out of the factory.

Corporation aims at meeting every user's demand with its most advanced productive technology and excellent quality. We sincerely invite people all over the world to share the pleasure of tools with us.



## NON-SPARKING TOOLS SERIES

A		02-11
B		12-36
C		37-43
D		44-56
E		57-61
F		62-64
G		65-77
H		78-86
<b>BRASS &amp; COPPER HAMMER SERIES</b>		
I		87-92



**NS101A** 1/4" Dr Socket Set-8pcs



Die Forged

- G.W.:  
Be-Cu 710g  
Al-Br 690g

Item No.	Contents
NS101A	Socket 4mm, 4.5mm, 5mm, 5.5mm, 6mm, 7mm, 8mm Driver Type Handle 55mm

**NS101D** 1/4\*3/8" Dr Socket Set-21pcs



Die Forged

- G.W.:  
Be-Cu 2131g  
Al-Br 2009g

Item No.	Contents
NS101D	1/4" Socket 4mm, 4.5mm, 5mm, 5.5mm, 6mm, 7mm, 8mm Ratchet Wrench 200mm Straight Joint Driver Extension 75mm, 150mm 3/8" Socket 10mm, 11mm, 12mm, 13mm, 14mm, 17mm, 19mm 13/16" Spark Plug Adaptor Driver Type Handle 55mm

**NS101G** 1/2" Dr Socket Set-17pcs



Die Forged

- G.W.:  
Be-Cu 6730g  
Al-Br 6355g

Item No.	Contents
NS101G	Socket 10mm, 11mm, 12mm, 14mm, 17mm, 19mm, 22mm, 24mm, 27mm, 30mm, 32mm Ratchet Wrench 245mm Sliding T-Handle 250mm Speed Handle 400mm Driver Extension 125mm, 250mm Socket Case

**NS101J** 1/2" Dr Socket Set-32pcs



Die Forged

- G.W.:  
Be-Cu 8980g  
Al-Br 8390g

Item No.	Contents
NS101J	Socket 8mm, 9mm, 10mm, 11mm, 12mm, 13mm, 14mm, 15mm, 16mm, 17mm, 18mm, 19mm, 20mm, 21mm, 22mm, 23mm, 24mm, 26mm, 27mm, 28mm, 30mm, 32mm 13/16" Spark Plug Ratchet Wrench 245mm Sliding T-Handle 250mm Speed Handle 400mm Driver Extension 125mm, 250mm Universal Joint 80mm Screwdriver Socket 52mm Offset Handle 230mm Socket Case

**NS101B** 1/4" Dr Socket Set-9pcs



Die Forged

- G.W.:  
Be-Cu 720g  
Al-Br 720g

Item No.	Contents
NS101B	Socket 4mm, 5mm, 6mm, 7mm, 8mm, 9mm, 10mm, 11mm Driver Type Handle 55mm

**NS101E** 1/2" Dr Socket Set-9pcs



Die Forged

- G.W.:  
Be-Cu 2000g  
Al-Br 1890g

Item No.	Contents
NS101E	Socket 10mm, 11mm, 12mm, 14mm, 17mm, 19mm, 22mm, 24mm Offset Handle 230mm

**NS101H** 1/2" Dr Socket Set-24pcs



Die Forged

- G.W.:  
Be-Cu 7370g  
Al-Br 7270g

Item No.	Contents
NS101H	Socket 10mm, 11mm, 12mm, 13mm, 14mm, 15mm, 16mm, 17mm, 18mm, 19mm, 20mm, 21mm, 22mm, 23mm, 24mm, 27mm, 30mm, 32mm Ratchet Wrench 245mm Sliding T-Handle 250mm Speed Handle 400mm Driver Extension 125mm, 250mm Universal Joint 80mm

**NS101K** 3/4" Dr Socket Set-14pcs



Die Forged

- G.W.:  
Be-Cu 13240g  
Al-Br 12350g

Item No.	Contents
NS101K	Socket 21mm, 24mm, 27mm, 30mm, 32mm, 34mm, 36mm, 38mm, 41mm, 46mm, 50mm Ratchet Wrench 320mm Sliding T-Handle 3/4" 400 Driver Extension 200mm

**NS101C** 3/8" Dr Socket Set-11pcs



Die Forged

- G.W.:  
Be-Cu 1740g  
Al-Br 1650g

Item No.	Contents
NS101C	Socket 10mm, 11mm, 12mm, 13mm, 14mm, 17mm, 19mm, 13/16" Spark Plug Ratchet Wrench 200mm Straight Joint Driver Extension 75mm

**NS101F** 1/2" Dr Socket Set-13pcs



Die Forged

- G.W.:  
Be-Cu 3390g  
Al-Br 3180g

Item No.	Contents
NS101F	Socket 8mm, 10mm, 11mm, 12mm, 14mm, 17mm, 19mm, 22mm, 24mm, 27mm Ratchet Wrench 245mm Hinged Handle 250mm Socket Case

**NS101I** 1/2" Dr Socket Set-28pcs



Die Forged

- G.W.:  
Be-Cu 9050g  
Al-Br 8520g

Item No.	Contents
NS101I	Socket 10mm, 11mm, 12mm, 13mm, 14mm, 15mm, 16mm, 17mm, 18mm, 19mm, 20mm, 21mm, 22mm, 23mm, 24mm, 26mm, 27mm, 28mm, 30mm, 32mm Ratchet Wrench 245mm Sliding T-Handle 250mm Speed Handle 400mm Driver Extension 125mm, 250mm Universal Joint 80mm Screwdriver Socket 52mm Socket Case

**NS101L** 3/4" Dr Socket Set-21pcs



Die Forged

- G.W.:  
Be-Cu 15270g  
Al-Br 14200g

Item No.	Contents
NS101L	Socket 21mm, 22mm, 23mm, 24mm, 26mm, 27mm, 28mm, 29mm, 30mm, 31mm, 32mm, 34mm, 36mm, 38mm, 41mm, 46mm, 50mm Ratchet Wrench 320mm Sliding T-Handle 3/4" 400 Driver Extension 200mm Socket Case

### NS101M 3/4" \* 1" Dr Socket Set-26pcs

Die Forged



- G.W.:  
Be-Cu 24900g  
Al-Br 23060g

Item No.	Contents
NS101M	Socket 21mm, 22mm, 23mm, 24mm, 26mm, 27mm, 28mm, 29mm, 30mm, 31mm, 32mm, 34mm, 36mm, 38mm, 41mm, 46mm, 50mm, 55mm, 60mm, 65mm Ratchet Wrench 160mm Sliding T-Handle 3/4" * 400 Driver Extension 200mm, 430mm 3/4" * 120mm Flex Ball Joint 3/4" * 1" Sliding T-Handle

### NS101N 1" Dr Socket Set-18pcs

Die Forged



- G.W.:  
Be-Cu 24900g  
Al-Br 24850g

Item No.	Contents
NS101N	Socket 30mm, 31mm, 32mm, 34mm, 36mm, 38mm, 41mm, 46mm, 50mm, 55mm, 60mm, 65mm, 70mm, 75mm, 80mm Sliding T-Handle 3/4" * 1" Driver Extension 200mm Flex Ball Joint 1" * 120mm

### NS124A Labor Saving Wrench



Item No.	size	Beryllium Copper (g)	Aluminium Bronze (g)
NS124A-1002	ZB-16	2000	1800
NS124A-1004	ZB-58	6850	6200
NS124A-1006	ZB-68	8050	7300
NS124A-1008	ZB-78	8300	7500

### Socket



DIN3120  
Die Forged

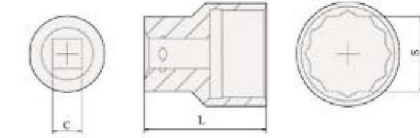

### NS102 Socket C=1/4"

Item No.	size (mm)	L (mm)	Beryllium Copper (g)	Aluminium Bronze (g)
NS102-4	4	25	11	10
NS102-4,5	4,5	25	11	10
NS102-5	5	25	12	11
NS102-5,5	5,5	25	12	11
NS102-6	6	25	13	12
NS102-7	7	25	13	12
NS102-8	8	25	15	14
NS102-9	9	25	21	20
NS102-10	10	25	22	20
NS102-11	11	25	22	20
NS102-12	12	26	25	22
NS102-13	13	26	26	24
NS102-14	14	26	27	25
NS102-15	15	27	33	30
NS102-16	16	27	34	31
NS102-17	17	27	35	32
NS102-18	18	27	36	33
NS102-19	19	27	38	35

Item No.	size (inch)	L (mm)	Beryllium Copper (g)	Aluminium Bronze (g)
NS102-1002	5/32	25	11	10
NS102-1004	3/16	25	11	10
NS102-1006	7/32	25	11	10
NS102-1008	1/4	25	11	10
NS102-1010	9/32	25	11	10
NS102-1012	5/16	25	17	15
NS102-1014	11/32	25	21	20
NS102-1016	3/8	25	23	21
NS102-1018	7/16	25	25	23
NS102-1020	1/2	26	33	30

### NS103 Socket C=3/8"

Item No.	size (mm)	L (mm)	Beryllium Copper (g)	Aluminium Bronze (g)
NS103-5	5	28	20	18
NS103-5,5	5,5	28	21	19
NS103-6	6	28	22	20
NS103-7	7	28	22	20
NS103-8	8	28	23	21
NS103-9	9	28	24	22
NS103-10	10	32	39	35
NS103-11	11	32	40	37
NS103-12	12	32	41	38
NS103-13	13	32	42	39
NS103-14	14	32	45	40
NS103-15	15	32	50	45
NS103-16	16	32	55	50
NS103-17	17	32	59	54
NS103-19	19	32	68	60
NS103-20	20	32	72	65

### NS103 Socket C=3/8"

Item No.	size (inch)	L (mm)	Beryllium Copper (g)	Aluminium Bronze (g)
NS103-1002	5/16	28	22	20
NS103-1004	3/8	28	31	28
NS103-1006	7/16	32	39	36
NS103-1008	1/2	32	40	38
NS103-1010	9/16	32	46	42
NS103-1012	5/8	32	70	65
NS103-1014	11/16	32	72	67
NS103-1016	3/4	32	75	69
NS103-1018	13/16	35	87	80
NS103-1020	7/8	35	93	85
NS103-1022	15/16	35	104	95

### NS104 Socket C=1/2"

Item No.	size (mm)	L (mm)	Beryllium Copper (g)	Aluminium Bronze (g)
NS104-6	6	40	75	69
NS104-7	7	40	77	70
NS104-8	8	40	77	70
NS104-9	9	40	78	71
NS104-10	10	40	78	71
NS104-11	11	40	79	72
NS104-12	12	40	79	72
NS104-13	13	40	80	73
NS104-14	14	40	80	73
NS104-15	15	40	82	75
NS104-16	16	40	85	77
NS104-17	17	40	88	80
NS104-18	18	42	90	82
NS104-19	19	42	110	100
NS104-20	20	42	120	105
NS104-21	21	43	125	110
NS104-22	22	43	130	115
NS104-23	23	43	150	135
NS104-24	24	43	165	145
NS104-25	25	43	180	160
NS104-26	26	43	200	180
NS104-27	27	46	215	190
NS104-28	28	46	225	200
NS104-29	29	46	235	210
NS104-30	30	46	250	220
NS104-32	32	46	295	260

Item No.	size (inch)	L (mm)	Beryllium Copper (g)	Aluminium Bronze (g)
NS104-1002	5/16	40	70	70
NS104-1004	3/8	40	78	71
NS104-1006	7/16	40	79	72
NS104-1008	1/2	40	80	73
NS104-1010	9/16	40	80	73
NS104-1012	5/8	40	88	80
NS104-1014	11/16	40	93	85
NS104-1016	3/4	42	110	100
NS104-1018	13/16	43	125	110
NS104-1020	7/8	43	130	115
NS104-1022	15/16	43	165	145
NS104-1024	1	43	190	170
NS104-1026	1-1/16	46	215	190
NS104-1028	1-1/4	46	295	260
NS104-1030	1-7/16	50	330	300



Socket

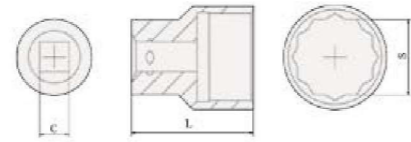

DIN3120 Die Forged

NS105 Socket C=3/4"

Item No.	size (mm)	L (mm)	Beryllium Copper (g)	Aluminium Bronze (g)
NS105-17	17	50	246	225
NS105-19	19	50	246	225
NS105-21	21	55	268	245
NS105-22	22	55	268	245
NS105-23	23	55	306	280
NS105-24	24	55	307	280
NS105-26	26	55	307	280
NS105-27	27	55	312	285
NS105-28	28	55	339	310
NS105-29	29	55	350	320
NS105-30	30	60	410	370
NS105-31	31	60	430	380
NS105-32	32	60	465	410
NS105-34	34	60	480	440
NS105-36	36	60	510	465
NS105-38	38	60	555	510
NS105-41	41	65	660	640
NS105-46	46	65	765	690
NS105-50	50	70	910	825

Item No.	size (inch)	L (mm)	Beryllium Copper (g)	Aluminium Bronze (g)
NS105-1002	3/4	50	240	220
NS105-1004	13/16	55	262	240
NS105-1006	7/8	55	267	245
NS105-1008	15/16	55	305	280
NS105-1010	1	55	310	280
NS105-1012	1-1/16	55	315	285
NS105-1014	1-1/8	55	345	315
NS105-1016	1-3/16	60	400	365
NS105-1018	1-1/4	60	437	400
NS105-1020	1-5/16	60	472	430
NS105-1022	1-3/8	60	515	470
NS105-1024	1-7/16	60	525	480
NS105-1026	1-1/2	60	580	530
NS105-1028	1-5/8	65	702	640
NS105-1030	1-3/4	65	761	695
NS105-1032	1-13/16	65	830	705
NS105-1034	1-7/8	65	850	750
NS105-1036	2	70	965	870

NS106 Socket C=1"

Item No.	size (mm)	L (mm)	Beryllium Copper (g)	Aluminium Bronze (g)
NS106-22	22	55	361	330
NS106-24	24	55	372	340
NS106-25	25	55	377	345
NS106-26	26	55	383	350
NS106-27	27	55	394	360
NS106-28	28	55	397	363
NS106-29	29	55	399	365
NS106-30	30	60	443	405
NS106-31	31	60	448	410
NS106-32	32	60	481	440
NS106-34	34	60	497	455
NS106-36	36	65	550	500
NS106-38	38	65	620	560
NS106-41	41	70	690	625
NS106-46	46	75	850	740
NS106-50	50	75	850	760
NS106-55	55	80	1160	1000
NS106-60	60	85	1390	1260
NS106-65	65	90	1750	1580
NS106-70	70	90	2150	1950
NS106-75	75	95	2680	2430
NS106-80	80	95	2930	2660

Item No.	size (inch)	L (mm)	Beryllium Copper (g)	Aluminium Bronze (g)
NS106-1002	1-1/16	55	394	360
NS106-1004	1-1/8	55	398	364
NS106-1006	1-3/16	60	442	405
NS106-1008	1-1/4	60	470	431
NS106-1010	1-5/16	60	483	442
NS106-1012	1-3/8	60	490	448
NS106-1014	1-7/16	65	560	500
NS106-1016	1-1/2	65	620	560
NS106-1018	1-5/8	70	690	625
NS106-1020	1-7/8	75	850	740
NS106-1022	2	75	960	850
NS106-1024	2-1/4	80	1250	1130
NS106-1026	2-1/2	90	1590	1350
NS106-1028	2-3/4	90	2050	1850
NS106-1030	3	95	2270	2060

Impact Socket

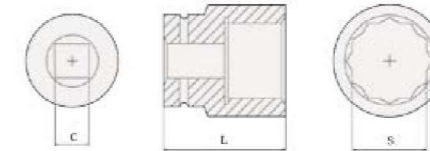

DIN3129 Die Forged

NS107 Impact Socket C=3/4"

Item No.	size (mm)	L (mm)	Beryllium Copper (g)	Aluminium Bronze (g)
NS107-24	24	50	380	330
NS107-27	27	53	405	365
NS107-30	30	53	440	390
NS107-32	32	56	475	425
NS107-36	36	56	650	585
NS107-41	41	60	695	625
NS107-46	46	60	770	700
NS107-50	50	70	1100	1000

NS108 Impact Socket C=1"

Item No.	size (mm)	L (mm)	Beryllium Copper (g)	Aluminium Bronze (g)
NS108-19	19	55	630	570
NS108-21	21	55	640	580
NS108-22	22	55	650	590
NS108-24	24	55	660	600
NS108-26	26	55	735	660
NS108-27	27	55	735	670
NS108-29	29	60	760	690
NS108-30	30	60	765	690
NS108-32	32	60	775	700
NS108-34	34	60	775	700
NS108-35	35	60	775	700
NS108-36	36	60	775	700
NS108-38	38	65	865	780
NS108-41	41	70	930	830
NS108-46	46	75	1380	1265
NS108-50	50	75	1455	1320
NS108-52	52	75	1715	1550
NS108-55	55	75	1830	1650
NS108-58	58	85	2080	1900
NS108-60	60	85	2200	2000
NS108-65	65	85	2460	2250
NS108-70	70	90	2890	2600
NS108-75	75	90	3155	2900
NS108-80	80	90	3560	3200

NS109 Impact Socket C=1-3/16"

Item No.	size (mm)	L (mm)	Beryllium Copper (g)	Aluminium Bronze (g)
NS109-50	50	90	1930	1755
NS109-52	52	90	2005	1835
NS109-55	55	90	2180	1965
NS109-58	58	90	2200	2000
NS109-60	60	90	2290	2085
NS109-65	65	90	2610	2370
NS109-70	70	90	2840	2585
NS109-75	75	90	3190	2880
NS109-80	80	90	3605	3250

NS110 Impact Socket C=1-1/4"

Item No.	size (mm)	L (mm)	Beryllium Copper (g)	Aluminium Bronze (g)
NS110-50	50	90	1950	1765
NS110-60	60	90	2300	2100
NS110-70	70	90	2750	2475

NS110A Impact Socket C=1-1/2"

Item No.	size (mm)	L (mm)	Beryllium Copper (g)	Aluminium Bronze (g)
NS110A-55	55	90	2020	1825
NS110A-60	60	90	2360	2135
NS110A-65	65	95	2390	2165
NS110A-70	70	95	2670	2415
NS110A-75	75	100	3180	2875
NS110A-80	80	100	3460	3130
NS110A-85	85	110	3950	3575
NS110A-90	90	110	4230	3830



### NS111 Flex Ball Joint

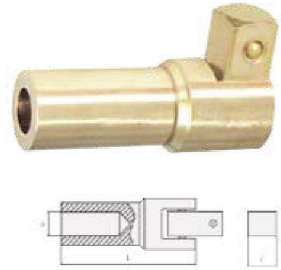

Item No.	C (inch)	L (mm)	Φ (mm)	Beryllium Copper (g)	Aluminium Bronze (g)
NS111-1002	3/4	120	21	880	800
NS111-1004	1	120	21	1160	1050

### NS112 Universal Joint

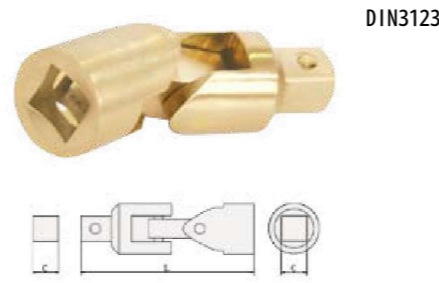

Item No.	C (inch)	L (mm)	Beryllium Copper (g)	Aluminium Bronze (g)
NS112-1002	1/2	80	186	170
NS112-1004	3/4	110	530	480
NS112-1006	1	132	1000	900

### NS113 Adaptor

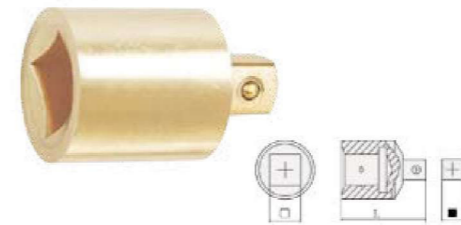

Item No.	□ (inch)	■ (inch)	L (mm)	Beryllium Copper (g)	Aluminium Bronze (g)
NS113-1002	3/8	1/4	26	22	20
NS113-1004	1/4	3/8	22	22	20
NS113-1006	1/2	3/8	34	80	70
NS113-1008	3/8	1/2	34	50	45
NS113-1010	3/4	1/2	55	290	260
NS113-1012	1/2	3/4	50	170	150
NS113-1014	1	3/4	70	855	770
NS113-1016	3/4	1	60	360	320
NS113-1018	1-1/2	1	85	1675	1510
NS113-1020	1	1-1/2	85	1230	1100

### NS117 Sliding T Handle



Item No.	C (inch)	L (mm)	H (mm)	Φ (mm)	Beryllium Copper (g)	Aluminium Bronze (g)
NS117-1002	1/2	250	39	13	340	310
NS117-1004	3/4	350	54	19	1070	960
NS117-1006	3/4	400	56	21	1335	1221
NS117-1008	1	400	62	21	1620	1481

### NS111A Internal Hexagon Socket

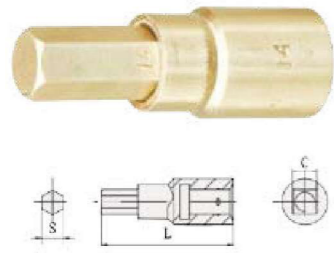

Item No.	C (inch)	S (mm)	L (mm)	Beryllium Copper (g)	Aluminium Bronze (g)
NS111A-1002	1/4	3	55	17	16
NS111A-1004	1/4	4	55	17	16
NS111A-1006	1/4	5	55	20	18
NS111A-1008	1/4	6	55	26	23
NS111A-1010	1/4	7	55	30	27
NS111A-1012	1/4	8	65	45	40
NS111A-1014	1/4	9	65	55	50
NS111A-1016	1/4	10	65	65	60

### NS111B Socket Wrench, Triangular



Item No.	C (inch)	M (mm)	L (mm)	Beryllium Copper (g)	Aluminium Bronze (g)
NS111B-1002	1/2	6	40	75	70
NS111B-1004	1/2	8	40	80	75
NS111B-1006	1/2	10	40	85	80
NS111B-1008	1/2	12	40	95	90
NS111B-1010	1/2	16	50	180	150
NS111B-1012	1/2	20	50	250	215
NS111B-1014	1/2	24	60	470	436

### NS115 Ratchet Wrench

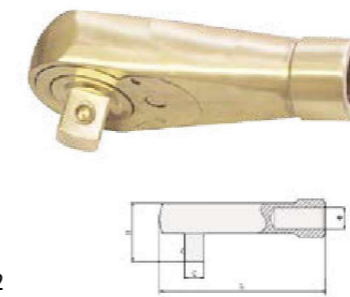

Item No.	C (inch)	L (mm)	Φ (mm)	H (mm)	Beryllium Copper (g)	Aluminium Bronze (g)
NS115-1002	3/4	160	21	55	1660	1530
NS115-1004	1	180	23	60	3270	2960

### NS118 Hinged Handle



Item No.	C (inch)	L (mm)	L <sub>1</sub> (mm)	Beryllium Copper (g)	Aluminium Bronze (g)
NS118-1002	3/8	190	175	245	220
NS118-1004	1/2	250	230	440	400
NS118-1006	1/2	320	300	565	510
NS118-1008	1/2	400	380	645	580
NS118-1010	3/4	286	260	635	570
NS118-1012	1	304	270	910	830

### NS111C Spark Plug Socket



Item No.	C (inch)	S (inch)	L (mm)	Beryllium Copper (g)	Aluminium Bronze (g)
NS111C-1002	3/8	13/16	62	180	160
NS111C-1004	1/2	13/16	62	160	145

### NS114 Screwdriver Socket

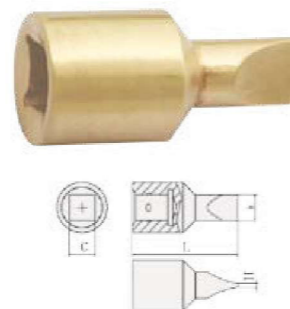

Item No.	C (inch)	L (mm)	H (mm)	B (mm)	Beryllium Copper (g)	Aluminium Bronze (g)
NS114-1002	1/2	52	2	13	102	91

### NS116 Sliding T Type Wrench



Item No.	C (inch)	L (mm)	Φ (mm)	H (mm)	Beryllium Copper (g)	Aluminium Bronze (g)
NS116-1002	3/4	350	19	200	1705	1550
NS116-1004	1	400	21	200	2590	2350

### NS119 Ratchet Wrench

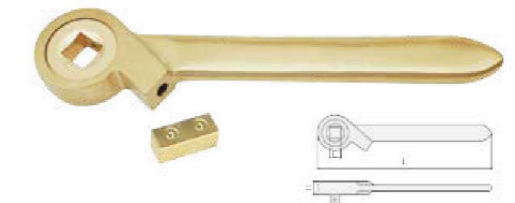

Item No.	C (inch)	L (mm)	H (mm)	Beryllium Copper (g)	Aluminium Bronze (g)
NS119-1002	1/4	200	16,5	350	305
NS119-1004	3/8	175	16,5	335	302
NS119-1006	3/8	200	16,5	400	360
NS119-1008	1/2	250	16,5	535	480
NS119-1010	3/4	300	22	1290	1170
NS119-1012	1	300	22	1590	1440

### NS120 Ratchet Wrench

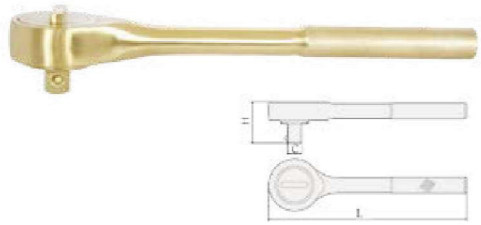

DIN3122

Item No.	C (inch)	L (mm)	H (mm)	Beryllium Copper (g)	Aluminium Bronze (g)
NS120-1002	3/8	200	30	290	260
NS120-1004	1/2	245	43	690	615
NS120-1006	3/4	320	57	1570	1430
NS120-1008	1	550	67	3400	3070

### NS121 Offset Handle

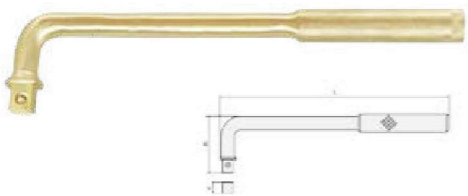

DIN3122

Item No.	C (inch)	L (mm)	H (mm)	Beryllium Copper (g)	Al-Cu (g)
NS121-1002	3/8	200	50	314	287
NS121-1004	1/2	230	60	410	380
NS121-1006	3/4	280	75	765	699
NS121-1008	1	300	85	1160	1060

### NS122 Driver Extension



Item No.	C (inch)	L (mm)	Beryllium Copper (g)	Aluminium Bronze (g)
NS122-1002	3/8	75	93	80
NS122-1004	3/8	150	185	160
NS122-1006	1/2	100	245	225
NS122-1008	1/2	125	260	230
NS122-1010	1/2	200	365	330
NS122-1012	1/2	250	470	425
NS122-1014	3/4	200	855	770
NS122-1016	1	200	1525	1380

### NS121A Wrench, Socket L-Type

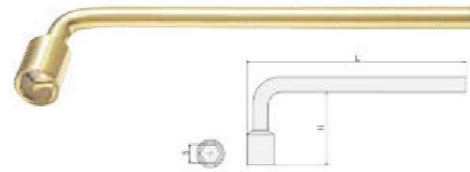

Item No.	S (mm)	L (mm)	H (mm)	Beryllium Copper (g)	Aluminium Bronze (g)
NS121A-6	6	120	29	100	35
NS121A-8	8	144	33	150	60
NS121A-10	10	168	37	200	90
NS121A-12	12	216	42	220	135
NS121A-13	13	240	45	250	190
NS121A-14	14	245	45	300	215
NS121A-15	15	250	48	350	240
NS121A-16	16	255	48	500	290
NS121A-17	17	260	51	550	325
NS121A-18	18	265	53	550	365
NS121A-19	19	270	55	550	400
NS121A-20	20	272	57	600	450
NS121A-21	21	275	57	750	550
NS121A-22	22	278	59	750	645
NS121A-23	23	282	60	800	680
NS121A-24	24	286	63	850	700
NS121A-27	27	294	69	900	800
NS121A-30	30	302	75	1000	880
NS121A-32	32	310	81	1100	950
NS121A-36	36	330	85	1300	1150
NS121A-41	41	350	90	1380	1410

### NS121B Sliding T Type Wrench



Item No.	S (mm)	L (mm)	H (mm)	Beryllium Copper (g)	Aluminium Bronze (g)
NS121B-7	7	120	120	100	90
NS121B-9	9	130	130	155	140
NS121B-11	11	140	150	190	170
NS121B-14	14	150	170	265	240
NS121B-17	17	170	190	410	370
NS121B-19	19	180	210	535	480
NS121B-22	22	190	240	750	680
NS121B-24	24	200	270	950	860
NS121B-27	27	200	270	1110	1000
NS121B-30	30	200	280	1340	1210
NS121B-32	32	200	280	1440	1300
NS121B-36	36	200	280	1980	1800

### NS121C Socket, Double End

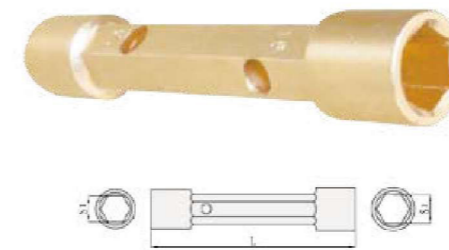

Item No.	S1* S2 (mm)	L (mm)	Beryllium Copper (g)	Aluminium Bronze (g)
NS121C-0607	6*7	105	70	65
NS121C-0809	8*9	115	90	80
NS121C-1011	10*11	120	110	120
NS121C-1213	12*13	140	170	160
NS121C-1415	14*15	140	255	230
NS121C-1617	16*17	155	440	340
NS121C-1819	18*19	165	520	460
NS121C-2022	20*22	175	630	570
NS121C-2123	21*23	185	670	600
NS121C-2427	24*27	195	870	785
NS121C-2528	25*28	205	965	870
NS121C-2730	27*30	210	1000	900

### NS123 Speed Handle

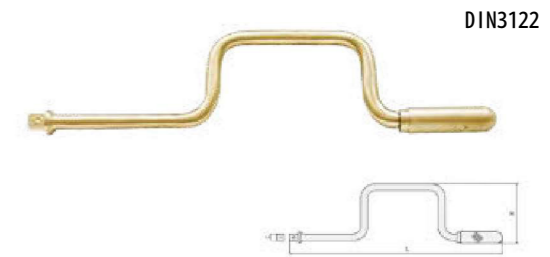

DIN3122

Item No.	C (inch)	L (mm)	H (mm)	Beryllium Copper (g)	Aluminium Bronze (g)
NS123-1002	1/2	390	96	780	700

### NS124 Driver Type Handle

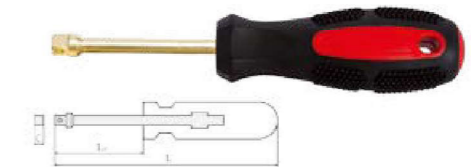

Item No.	C (inch)	L (mm)	L1 (mm)	Beryllium Copper (g)	Aluminium Bronze (g)
NS124-1002	1/4	163	55	85	62

NON-SPARKING TOOLS NON-MAGNETIC  
THE BEST MANUFACTURER YOU ARE LOOKING FOR.



**NS125** Wrench, Adjustable



Item No.	L (mm)	K <sub>max</sub> (mm)	Beryllium Copper (g)	Aluminium Bronze (g)
NS125-1002	100	13	33	30
NS125-1004	150	18	135	120
NS125-1006	200	24	281	255
NS125-1008	250	30	440	401
NS125-1010	300	36	720	655
NS125-1012	375	46	1410	1290
NS125-1014	450	55	2261	2065
NS125-1016	600	65	4705	4301

**NS127** Wrench, Monkey

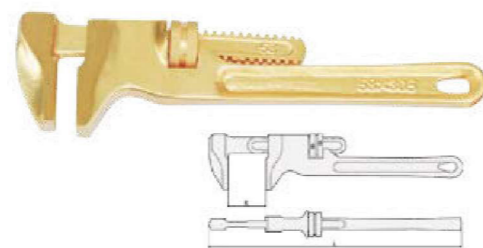

Item No.	L (mm)	K <sub>max</sub> (mm)	Beryllium Copper (g)	Aluminium Bronze (g)
NS127-1002	240	45	510	470
NS127-1004	254	48	615	560
NS127-1006	305	58	910	820
NS127-1008	350	65	1220	1120
NS127-1010	380	70	1465	1340

**NS128B** Wrench, Swedish Type 90

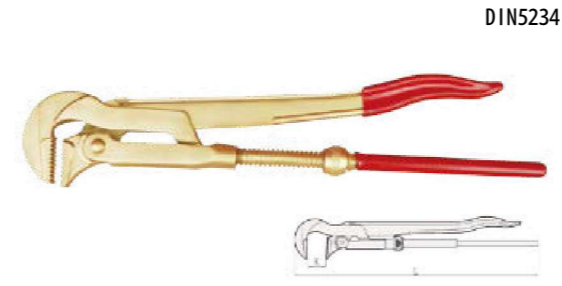

DIN5234

Item No.	L (mm)	K (mm)	Beryllium Copper (g)	Aluminium Bronze (g)
NS128B-1002	430	38	1480	1330

**NS129B** Wrench, Belt Pipe

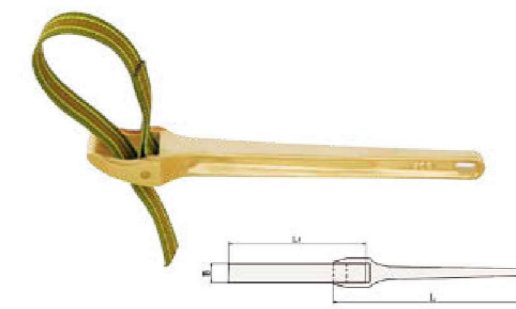

Item No.	L (mm)	L <sub>1</sub> (mm)	B (mm)	Beryllium Copper (g)	Aluminium Bronze (g)
NS129B-1002	300	425	30	810	735

**NS125A** Wrench, Adjustable



Item No.	L (mm)	K <sub>max</sub> (mm)	Beryllium Copper (g)	Aluminium Bronze (g)
NS125A-1002	100	13	33	30
NS125A-1004	150	18	135	120
NS125A-1006	200	24	281	255
NS125A-1008	250	30	440	401
NS125A-1010	300	36	720	655
NS125A-1012	375	46	1410	1290
NS125A-1014	450	55	2261	2065
NS125A-1016	600	65	4705	4301

**NS128** Wrench, Swedish Type 45

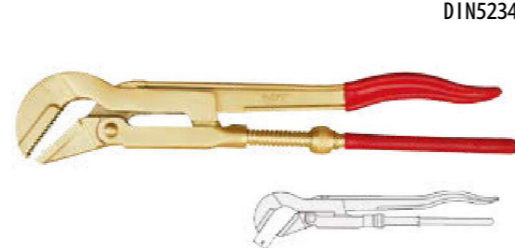

DIN5234

Item No.	L (mm)	K (mm)	Beryllium Copper (g)	Aluminium Bronze (g)
NS128-1002	430	38	1550	1400
NS128-1004	530	50	2230	2000

**NS129A** Wrench, Chain Pipe Light



Item No.	L (mm)	D <sub>max</sub> (mm)	Beryllium Copper (g)	Aluminium Bronze (g)
NS129A-1002	600	100	2105	1910
NS129A-1004	1600	450	10500	9500

**NS129C** Universal Wrench



Item No.	L (mm)	D (mm)	Beryllium Copper (g)	Aluminium Bronze (g)
NS129C-1002	250	10-30	870	780
NS129C-1004	450	30-60	2450	2200

**NS126** Wrench, Adjustable



Item No.	L (mm)	K <sub>max</sub> (mm)	H (mm)	Beryllium Copper (g)	Aluminium Bronze (g)
NS126-1002	350	36	80	1384	1251

**NS128A** Wrench, Swedish Type

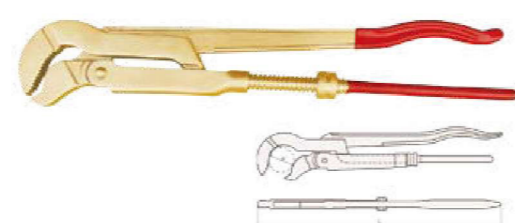

DIN5234

Item No.	L (mm)	D (inch)	Beryllium Copper (g)	Aluminium Bronze (g)
NS128A-1002	530	2	2605	2355
NS128A-1004	650	3	4500	4060
NS128A-1006	790	4	6200	5600

**NS129** Wrench, Chain Pipe



DIN17200

Item No.	L (mm)	D <sub>max</sub> (mm)	Beryllium Copper (g)	Aluminium Bronze (g)
NS129-1002	600	100	3955	3605
NS129-1004	600	150	4650	4200
NS129-1006	900	200	8600	7800
NS129-1008	900	300	9810	9000

**NS130A** Wrench, Pipe



Item No.	L (mm)	K <sub>max</sub> (mm)	Beryllium Copper (g)	Aluminium Bronze (g)
NS130A-1002	200	25	420	380
NS130A-1004	250	30	610	550
NS130A-1006	300	40	787	750
NS130A-1008	350	50	1155	1050
NS130A-1010	450	60	1874	1705
NS130A-1012	600	75	3417	3110
NS130A-1014	900	125	6336	5765
NS130A-1016	1200	150	12894	11410

**NS131A** Wrench, Pipe (American Type)

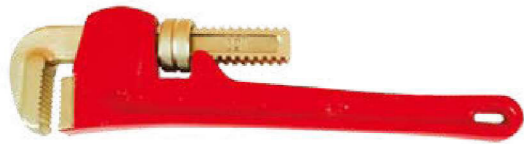

Item No.	L (mm)	K <sub>max</sub> (mm)	Beryllium Copper (g)	Aluminium Bronze (g)
NS131A-1002	200	25	460	418
NS131A-1004	250	30	810	738
NS131A-1006	300	40	1158	1050
NS131A-1008	350	50	1450	1318
NS131A-1010	450	60	2485	2260
NS131A-1012	600	75	3820	3470
NS131A-1014	900	85	6482	5890
NS131A-1016	1200	110	13890	12620

**NS131D** Wrench, Pipe (Hex Type)

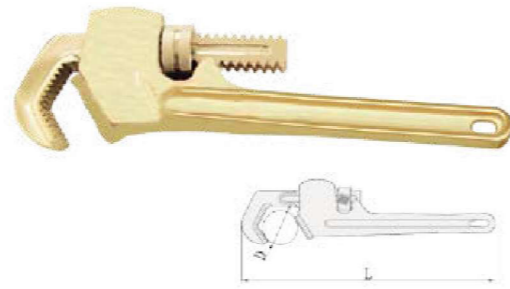

Item No.	L (mm)	D <sub>max</sub> (mm)	Beryllium Copper (g)	Aluminium Bronze (g)
NS131D-1002	250	30	1250	1130
NS131D-1004	350	30	1785	1620

**NS130** Wrench, Pipe

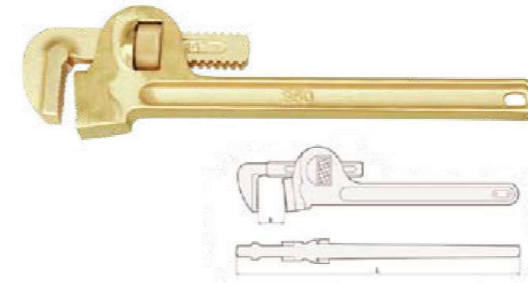

Item No.	L (mm)	K <sub>max</sub> (mm)	Beryllium Copper (g)	Aluminium Bronze (g)
NS130-1002	200	25	420	380
NS130-1004	250	30	610	550
NS130-1006	300	40	787	750
NS130-1008	350	50	1155	1050
NS130-1010	450	60	1874	1705
NS130-1012	600	75	3417	3110
NS130-1014	900	125	6336	5765
NS130-1016	1200	150	12894	11410

**NS132** Set-9pcs Wrench, Combination



Item No.	S (mm)	Beryllium Copper (g)	Aluminium Bronze (g)
NS132	8,10,12,14,17,19,22,24,27	1815	1655

**NS131B** Wrench, Pipe (Diagonal Type)



Item No.	L (mm)	D <sub>max</sub> (mm)	Beryllium Copper (g)	Aluminium Bronze (g)
NS131B-1002	200	34	560	510
NS131B-1004	250	48	930	840
NS131B-1006	300	50	1470	1330
NS131B-1008	375	60	1780	1610
NS131B-1010	450	76	2650	2400

**NS131E** Wrench, Pipe (Bent & Hex Type)



Item No.	L (mm)	D <sub>max</sub> (mm)	Beryllium Copper (g)	Aluminium Bronze (g)
NS131E-1002	250	30	1250	1130
NS131E-1004	350	30	1785	1620

**NS131** Wrench, Pipe (American Type)

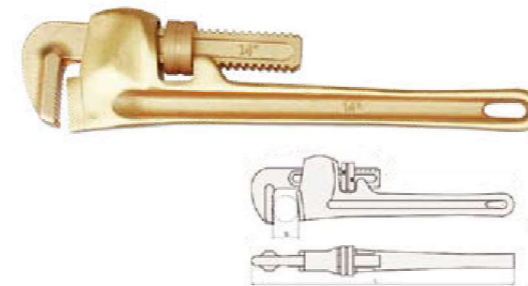

Item No.	L (mm)	K <sub>max</sub> (mm)	Beryllium Copper (g)	Aluminium Bronze (g)
NS131-1002	200	25	460	418
NS131-1004	250	30	810	738
NS131-1006	300	40	1158	1050
NS131-1008	350	50	1450	1318
NS131-1010	450	60	2485	2260
NS131-1012	600	75	3820	3470
NS131-1014	900	85	6482	5890
NS131-1016	1200	110	13890	12620

**NS136A** Wrench, Combination Ratchet

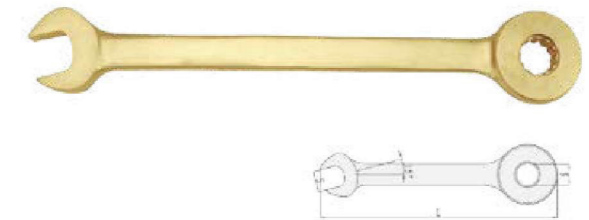

Item No.	S (mm)	L (mm)	Beryllium Copper (g)	Aluminium Bronze (g)
NS136A-17	17	220	250	225
NS136A-19	19	240	310	280
NS136A-22	22	270	420	380
NS136A-24	24	290	570	510
NS136A-27	27	315	750	675
NS136A-30	30	350	1000	900
NS136A-32	32	370	1155	1040

**NS131C** Wrench, Pipe (Bent Type)

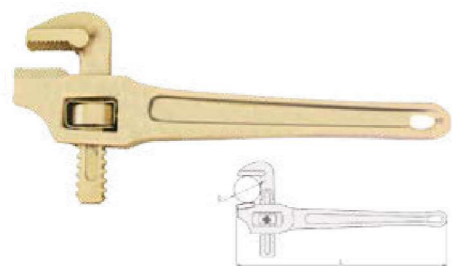

Item No.	L (mm)	D <sub>max</sub> (mm)	Beryllium Copper (g)	Aluminium Bronze (g)
NS131C-1002	200	34	500	450
NS131C-1004	250	48	850	780
NS131C-1006	300	50	1200	1090
NS131C-1008	375	60	1950	1770
NS131C-1010	450	76	2730	2480

**NS131F** Wrench, Pipe (Rapid Grip)

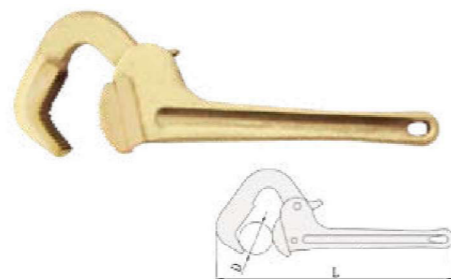

Item No.	L (mm)	D <sub>max</sub> (mm)	Beryllium Copper (g)	Aluminium Bronze (g)
NS131F-1002	250	48	980	880
NS131F-1004	350	60	1900	1710



### NS135 Wrench, Combination



DIN3113



Item No.	S (mm)	L (mm)	Beryllium Copper (g)	Aluminium Bronze (g)
NS135-6	6	105	22	20
NS135-7	7	120	37	34
NS135-8	8	120	37	34
NS135-9	9	135	55	50
NS135-10	10	135	55	50
NS135-11	11	150	75	75
NS135-12	12	150	75	70
NS135-13	13	175	122	110
NS135-14	14	175	122	110
NS135-15	15	195	160	145
NS135-16	16	195	155	140
NS135-17	17	195	155	140
NS135-18	18	215	210	190
NS135-19	19	215	210	190
NS135-20	20	230	225	200
NS135-21	21	230	225	200
NS135-22	22	245	250	220
NS135-23	23	265	265	233
NS135-24	24	265	260	230
NS135-25	25	265	260	230
NS135-26	26	290	420	380
NS135-27	27	290	420	380
NS135-30	30	320	560	500
NS135-32	32	340	670	600
NS135-34	34	360	850	750
NS135-35	35	360	890	800
NS135-36	36	360	890	800
NS135-38	38	430	1440	1300
NS135-41	41	430	1440	1300
NS135-46	46	480	1890	1700
NS135-50	50	520	2220	2000
NS135-55	55	560	2460	2230
NS135-60	60	595	3300	2950
NS135-65	65	595	3250	2900
NS135-70	70	630	4550	4100

Item No.	S (inch)	L (mm)	Beryllium Copper (g)	Aluminium Bronze (g)
NS135A-1002	1/4	105	22	20
NS135A-1004	5/16	120	37	34
NS135A-1006	3/8	135	55	50
NS135A-1008	7/16	150	75	70
NS135A-1010	1/2	175	125	115
NS135A-1012	9/16	175	122	110
NS135A-1014	19/32	195	160	145
NS135A-1016	5/8	195	155	140
NS135A-1018	11/16	195	155	140
NS135A-1020	3/4	215	210	190
NS135A-1022	13/16	230	225	200
NS135A-1024	7/8	245	250	225
NS135A-1026	15/16	265	260	230
NS135A-1028	1	265	260	230
NS135A-1030	1-1/16	290	420	380
NS135A-1032	1-1/8	320	560	500
NS135A-1034	1-3/16	320	560	500
NS135A-1036	1-1/4	340	670	600
NS135A-1038	1-5/16	360	850	750
NS135A-1040	1-3/8	360	890	800

### NS136 Wrench, Combination



DIN3113

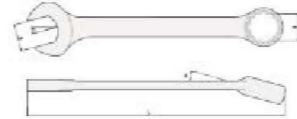

Item No.	S (mm)	L (mm)	Beryllium Copper (g)	Aluminium Bronze (g)
NS136-6	6	105	18	16
NS136-7	7	120	40	40
NS136-8	8	120	40	40
NS136-9	9	135	45	42
NS136-10	10	135	45	42
NS136-11	11	150	65	60
NS136-12	12	150	65	60
NS136-13	13	175	90	82
NS136-14	14	175	90	82
NS136-15	15	195	140	125
NS136-16	16	195	140	125
NS136-17	17	195	140	125
NS136-18	18	215	180	165
NS136-19	19	215	180	165
NS136-20	20	215	180	165
NS136-21	21	245	280	260
NS136-22	22	245	280	260
NS136-23	23	265	320	290
NS136-24	24	265	320	290
NS136-25	25	265	500	455
NS136-26	26	290	500	455
NS136-27	27	290	500	455
NS136-30	30	320	700	635
NS136-32	32	340	780	710
NS136-34	34	360	1000	910
NS136-36	36	360	1000	910
NS136-38	38	430	1450	1310
NS136-41	41	430	1420	1190
NS136-46	46	480	1760	1590
NS136-50	50	520	2020	1830
NS136-55	55	560	2000	1810
NS136-60	60	595	2920	2640
NS136-65	65	595	3440	3110
NS136-70	70	630	4130	3730
NS136-75	75	630	4000	3620
NS136-80	80	660	5400	4880
NS136-85	85	660	5320	4800
NS136-90	90	720	7100	6410
NS136-95	95	720	7000	6250
NS136-100	100	780	8950	8100
NS136-110	110	780	10350	9369
NS136-120	120	900	12750	11560

### NS136B Wrench, Combination



Item No.	S (mm)	L (mm)	Beryllium Copper (g)	Aluminium Bronze (g)
NS136B-17	17	195	161	148
NS136B-19	19	215	210	90
NS136B-22	22	245	280	260
NS136B-24	24	265	380	335
NS136B-27	27	285	484	444
NS136B-30	30	310	656	600
NS136B-32	32	330	770	705
NS136B-36	36	345	1090	1002
NS136B-41	41	366	1220	1120
NS136B-46	46	405	1550	1420
NS136B-50	50	420	1735	1590
NS136B-55	55	445	2210	2025
NS136B-60	60	462	2585	2365
NS136B-65	65	470	2980	2740

### NS138 Wrench, Bent Open End

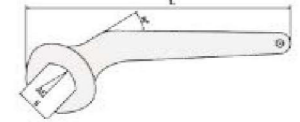

Item No.	S (mm)	L (mm)	Beryllium Copper (g)	Aluminium Bronze (g)
NS138-12	12	120	55	50
NS138-14	14	130	90	80
NS138-17	17	150	125	115
NS138-19	19	170	180	165
NS138-22	22	190	250	230
NS138-24	24	210	255	235
NS138-27	27	230	380	350
NS138-30	30	250	490	450
NS138-32	32	270	590	545
NS138-34	34	280	720	660
NS138-36	36	290	850	780
NS138-41	41	310	1090	1005
NS138-46	46	330	1340	1225
NS138-50	50	350	1615	1480
NS138-55	55	370	2135	1955

### NS137 Wrench, Combination

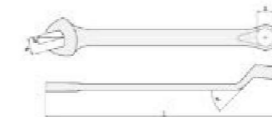

Item No.	S (mm)	L (mm)	Beryllium Copper (g)	Aluminium Bronze (g)
NS137-17	17	240	230	210
NS137-19	19	270	280	250
NS137-21	21	290	380	340
NS137-22	22	295	440	370
NS137-24	24	320	460	390
NS137-27	27	350	605	520

### NS139 Wrench, Construction With Pin



Item No.	S (mm)	L (mm)	Beryllium Copper (g)	Aluminium Bronze (g)
NS139-17	17	220	125	115
NS139-19	19	240	160	145
NS139-22	22	260	210	190
NS139-24	24	280	265	240
NS139-27	27	300	350	315
NS139-30	30	320	445	405
NS139-32	32	340	530	480
NS139-36	36	360	720	650
NS139-41	41	380	1010	910
NS139-46	46	400	1115	1010
NS139-50	50	420	1165	1055
NS139-55	55	450	1485	1345
NS139-60	60	480	2015	1825

### NS140 Wrench, Single Open End

DIN894



Item No.	S (mm)	L (mm)	Beryllium Copper (g)	Aluminium Bronze (g)
NS140-8	8	95	40	35
NS140-10	10	100	50	45
NS140-12	12	110	65	60
NS140-14	14	140	95	85
NS140-17	17	160	105	95
NS140-19	19	170	130	115
NS140-22	22	195	170	152
NS140-24	24	220	190	170
NS140-27	27	240	285	260
NS140-30	30	260	320	290
NS140-32	32	275	400	365
NS140-34	34	290	455	410
NS140-36	36	310	530	480
NS140-41	41	345	615	555
NS140-46	46	375	950	860
NS140-50	50	410	1080	950
NS140-55	55	450	1380	1200
NS140-60	60	490	1950	1700
NS140-65	65	530	2250	2000
NS140-70	70	570	2850	2550
NS140-75	75	610	3200	2800

### NS140B Wrench, Construction, Offset Type With Pin

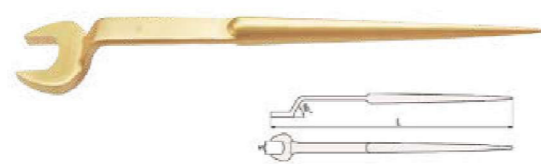

Item No.	S (mm)	L (mm)	Beryllium Copper (g)	Aluminium Bronze (g)
NS140B-17	17	320	210	195
NS140B-19	19	350	320	290
NS140B-22	22	350	430	390
NS140B-24	24	370	480	430
NS140B-27	27	370	640	580
NS140B-30	30	400	800	720
NS140B-32	32	400	800	720
NS140B-36	36	430	950	860
NS140B-41	41	470	1270	1150
NS140B-46	46	500	1600	1445
NS140B-50	50	530	1885	1700
NS140B-55	55	560	2160	1950

### NS140C T-Handle Wrench



Item No.	S (mm)	K (mm)	L (mm)	Beryllium Copper (g)	Aluminium Bronze (g)
NS140C-8	8	5	215	135	120
NS140C-10	10	6	215	140	125
NS140C-12	12	8	215	145	130
NS140C-14	14	10	215	150	135

### NS140D Wrench, Single Open End



Item No.	S (mm)	L (mm)	Beryllium Copper (g)	Aluminium Bronze (g)
NS140D-22	22	180	220	180
NS140D-24	24	196	235	195
NS140D-27	27	225	330	280
NS140D-30	30	255	450	390
NS140D-32	32	275	602	520
NS140D-36	36	300	901	775
NS140D-41	41	325	1040	950
NS140D-46	46	350	1180	1080

### NS141 Wrench, Striking Open

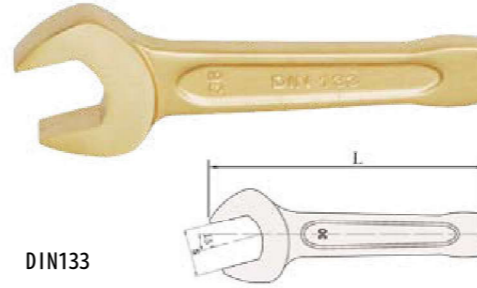

DIN133

Item No.	S (mm)	L (mm)	Beryllium Copper (g)	Aluminium Bronze (g)
NS141-17	17	125	150	135
NS141-19	19	125	150	135
NS141-22	22	135	195	175
NS141-24	24	150	245	220
NS141-27	27	175	335	300
NS141-30	30	190	435	390
NS141-32	32	190	515	460
NS141-36	36	200	725	655
NS141-41	41	230	955	860
NS141-46	46	250	1225	1100
NS141-50	50	275	1560	1420
NS141-55	55	305	1850	1680
NS141-60	60	315	2190	1970
NS141-65	65	335	3060	2780
NS141-70	70	370	4030	3660
NS141-75	75	375	4200	3800
NS141-80	80	400	5650	5130
NS141-85	85	400	6000	5400
NS141-90	90	445	7800	7050
NS141-95	95	445	7730	7000
NS141-100	100	485	11600	10500
NS141-110	110	513	13500	12000

Item No.	S (inch)	L (mm)	Beryllium Copper (g)	Aluminium Bronze (g)
NS141-1002	3/4	125	150	135
NS141-1004	7/8	135	195	175
NS141-1006	15/16	150	245	220
NS141-1008	1	175	335	300
NS141-1010	1-1/8	190	435	390
NS141-1012	1-1/4	190	515	460
NS141-1014	1-7/16	200	725	655
NS141-1016	1-1/2	220	860	780
NS141-1018	1-5/8	230	955	860
NS141-1020	1-3/4	250	1225	1100
NS141-1022	1-7/8	250	1225	1100
NS141-1024	2	275	1550	1400
NS141-1028	2-1/8	305	1850	1680
NS141-1030	2-1/4	315	2190	1970
NS141-1032	2-3/8	315	2190	1970
NS141-1034	2-1/2	335	3060	2780
NS141-1036	2-3/4	370	4030	3660
NS141-1038	3	375	4200	3800
NS141-1040	3-1/8	400	5650	5130
NS141-1042	3-1/2	445	7800	7050
NS141-1044	3-3/4	445	7730	7000
NS141-1046	4	485	11600	10500

### NS141A Wrench, Striking Open



Item No.	S (mm)	L (mm)	Beryllium Copper (g)	Aluminium Bronze (g)
NS141A-17	17	130	133	120
NS141A-19	19	140	172	155
NS141A-22	22	155	252	230
NS141A-24	24	165	305	275
NS141A-27	27	175	385	350
NS141A-30	30	185	515	470
NS141A-32	32	195	585	535
NS141A-36	36	210	851	780
NS141A-41	41	225	1055	965
NS141A-46	46	240	1245	1140
NS141A-50	50	255	1580	1445
NS141A-55	55	270	1865	1705
NS141A-60	60	285	2205	2015
NS141A-65	65	305	3060	2805
NS141A-70	70	325	3620	3310
NS141A-75	75	345	3905	3570
NS141A-80	80	365	4845	4440
NS141A-90	90	385	5370	4920

### NS141B Wrench, Bent Striking Open



Item No.	S (mm)	L (mm)	Beryllium Copper (g)	Aluminium Bronze (g)
NS141B-17	17	125	160	150
NS141B-19	19	125	160	150
NS141B-22	22	135	180	160
NS141B-24	24	150	245	220
NS141B-27	27	175	420	380
NS141B-30	30	190	480	440
NS141B-32	32	190	480	440
NS141B-34	34	200	600	540
NS141B-36	36	210	680	620
NS141B-38	38	230	980	800
NS141B-41	41	230	950	860
NS141B-46	46	250	1270	1150
NS141B-50	50	275	1380	1250
NS141B-55	55	305	1780	1620
NS141B-60	60	315	2560	2350
NS141B-65	65	335	3000	2750



**NS142** Set-9pcs Wrench, Double Open End



Item No.	S1*S2 (mm)	Beryllium Copper (g)	Aluminium Bronze (g)
NS142	8*10, 10*12, 12*14, 14*17, 17*19, 19*22, 22*24, 24*27, 30*32	2810	2570

**NS143** Set-11pcs Wrench, Double Open End

Item No.	S1*S2 (mm)	Beryllium Copper (g)	Aluminium Bronze (g)
NS143	8*10, 9*11, 10*12, 12*14, 14*17, 17*19, 19*22, 22*24, 24*27, 27*30, 30*32	3530	3230

**NS144** Set-13pcs Wrench, Double Open End

Item No.	S1*S2 (mm)	Beryllium Copper (g)	Aluminium Bronze (g)
NS144	5.5*7, 6*7, 8*10, 9*11, 10*12, 12*14, 14*17, 17*19, 19*22, 22*24, 24*27, 27*30, 30*32	3610	3295

**NS145** Wrench, Double Open End



Item No.	S1*S2 (mm)	L (mm)	Beryllium Copper (g)	Aluminium Bronze (g)
NS145-0607	6*7	92	40	35
NS145-0709	7*9	96	45	40
NS145-0810	8*10	100	60	55
NS145-0911	9*11	110	75	70
NS145-1012	10*12	120	95	87
NS145-1214	12*14	130	145	133
NS145-1417	14*17	150	180	165
NS145-1719	17*19	170	235	215
NS145-1922	19*22	185	330	302
NS145-2224	22*24	210	445	430
NS145-2427	24*27	230	535	490
NS145-2730	27*30	250	650	593
NS145-3032	30*32	265	775	710
NS145-3036	30*36	270	925	845
NS145-3234	32*34	275	1055	965
NS145-3236	32*36	290	1155	1055
NS145-3436	34*36	305	1475	1350
NS145-3641	36*41	335	1610	1470
NS145-4146	41*46	355	1790	1640
NS145-4650	46*50	370	2220	2030
NS145-5055	50*55	385	2610	2385
NS145-5060	50*60	400	3085	2820
NS145-5560	55*60	415	3270	2990
NS145-6065	60*65	435	4540	4150
NS145-6570	65*70	460	6130	5605

**NS146** Wrench, Double Open End

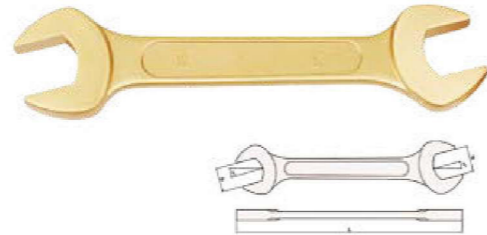

Item No.	S1*S2 (mm)	L (mm)	Beryllium Copper (g)	Aluminium Bronze (g)
NS146-0507	5.5*7	90	23	20
NS146-0607	6*7	92	25	22
NS146-0709	7*9	96	28	25
NS146-0810	8*10	100	34	31
NS146-0911	9*11	110	50	45
NS146-1011	10*11	115	52	47
NS146-1012	10*12	120	60	55
NS146-1014	10*14	124	68	62
NS146-1213	12*13	128	73	67
NS146-1214	12*14	130	75	69
NS146-1317	13*17	140	110	100
NS146-1415	14*15	143	115	105
NS146-1417	14*17	150	120	110
NS146-1617	16*17	157	130	120
NS146-1618	16*18	163	145	130
NS146-1719	17*19	170	150	135
NS146-1721	17*21	173	185	165
NS146-1819	18*19	179	200	180
NS146-1921	19*21	182	210	190
NS146-1922	19*22	185	220	200
NS146-1924	19*24	190	235	210
NS146-2022	20*22	195	250	225
NS146-2123	21*23	200	270	235
NS146-2126	21*26	205	275	245
NS146-2224	22*24	210	312	285
NS146-2227	22*27	215	320	292
NS146-2326	23*26	220	330	302
NS146-2427	24*27	230	345	310
NS146-2430	24*30	233	365	330
NS146-2528	25*28	236	365	330
NS146-2632	26*32	243	465	420
NS146-2730	27*30	250	485	430
NS146-2732	27*32	255	600	549
NS146-3032	30*32	265	610	540
NS146-3036	30*36	270	815	730
NS146-3234	32*34	270	815	730
NS146-3236	32*36	300	885	800
NS146-3436	34*36	300	885	800
NS146-3638	36*38	330	1350	1210
NS146-3641	36*41	330	1350	1210
NS146-3840	38*40	330	1350	1210
NS146-4146	41*46	355	1590	1430
NS146-4650	46*50	370	2050	1850
NS146-5055	50*55	385	2160	1950
NS146-5060	50*60	400	2488	2275
NS146-5560	55*60	415	2700	2450
NS146-6065	60*65	435	3950	3600

**NS146A** Wrench, Double Open End



Item No.	S1*S2 (mm)	L (mm)	Beryllium Copper (g)	Aluminium Bronze (g)
NS146A-1002	14*17	160	110	100
NS146A-1004	17*19	180	120	110
NS146A-1006	19*22	200	160	140
NS146A-1008	19*24	220	180	160
NS146A-1010	22*24	230	240	220
NS146A-1012	24*27	255	340	305
NS146A-1014	27*30	280	420	380
NS146A-1016	30*32	300	530	480
NS146A-1018	32*36	320	635	570
NS146A-1020	34*36	330	740	670
NS146A-1022	36*41	350	900	810
NS146A-1024	41*46	380	1060	955
NS146A-1026	46*50	420	1310	1190
NS146A-1028	50*55	460	1900	1720
NS146A-1030	55*60	500	2800	2530

**NS147** Wrench, Double Open End

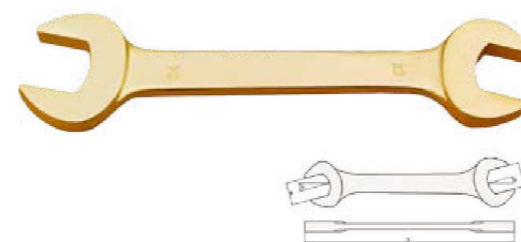

Item No.	S1*S2 (mm)	L (mm)	Beryllium Copper (g)	Aluminium Bronze (g)
NS147-1002	1/4*5/16	90	34	30
NS147-1004	5/16*3/8	100	45	40
NS147-1006	3/8*7/16	110	60	55
NS147-1008	3/8*1/2	115	68	60
NS147-1010	7/16*1/2	120	85	78
NS147-1012	1/2*9/16	130	90	80
NS147-1014	9/16*5/8	150	120	105
NS147-1016	5/8*11/16	160	155	130
NS147-1018	5/8*3/4	165	160	135
NS147-1020	11/16*3/4	170	170	145
NS147-1022	3/4*13/16	180	225	185
NS147-1024	3/4*7/8	185	230	200
NS147-1026	13/16*7/8	190	240	215
NS147-1028	7/8*15/16	210	305	270
NS147-1030	15/16*1	220	365	305
NS147-1032	1*1-1/16	230	405	355
NS147-1034	1-1/16*1-1/8	235	450	380
NS147-1036	1-1/8*1-3/16	245	548	480
NS147-1038	1-3/16*1-1/4	250	600	525

**NS148** Set-9pcs Wrench, Double Box Offset



Item No.	S1*S2 (mm)	Beryllium Copper (g)	Aluminium Bronze (g)
NS148	8*10, 10*12, 12*14, 14*17, 17*19, 19*22, 22*24, 24*27, 30*32	2815	2575

**NS149** Set-11pcs Wrench, Double Box Offset

Item No.	S1*S2 (mm)	Beryllium Copper (g)	Aluminium Bronze (g)
NS149	8*10, 9*11, 10*12, 12*14, 14*17, 17*19, 19*22, 22*24, 24*27, 27*30, 30*32	3585	3275

**NS150** Set-13pcs Wrench, Double Box Offset

Item No.	S1*S2 (mm)	Beryllium Copper (g)	Aluminium Bronze (g)
NS150	5.5*7, 6*7, 8*10, 9*11, 10*12, 12*14, 14*17, 17*19, 19*22, 22*24, 24*27, 27*30, 30*32	3630	3320

**NS151A** Wrench, Double Box Offset

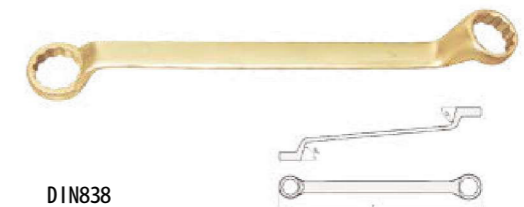

Item No.	S1*S2 (mm)	L (mm)	Beryllium Copper (g)	Aluminium Bronze (g)
NS151A-1719	17*19	280	180	160
NS151A-1922	19*22	300	210	190
NS151A-1924	19*24	320	320	290
NS151A-2123	21*23	320	370	335
NS151A-2224	22*24	330	420	380
NS151A-2427	24*27	340	480	430
NS151A-2730	27*30	350	530	480
NS151A-3032	30*32	370	690	620
NS151A-3236	32*36	430	1000	910
NS151A-3641	36*41	470	1270	1150
NS151A-4146	41*46	500	1580	1430
NS151A-4650	46*50	525	1900	1720
NS151A-5055	50*55	550	2850	2580

**NS151** Wrench, Double Box Offset

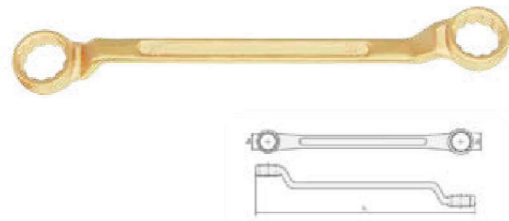

Item No.	S1*S2 (mm)	L (mm)	Beryllium Copper (g)	Aluminium Bronze (g)
NS151-0507	5,5*7	115	22	20
NS151-0607	6*7	115	25	23
NS151-0709	7*9	130	50	46
NS151-0810	8*10	130	55	50
NS151-0911	9*11	140	70	65
NS151-1011	10*11	140	80	75
NS151-1012	10*12	140	85	78
NS151-1213	12*13	160	120	110
NS151-1214	12*14	160	151	140
NS151-1417	14*17	220	205	180
NS151-1618	16*18	220	220	202
NS151-1719	17*19	250	225	205
NS151-1722	17*22	250	290	265
NS151-1819	18*19	250	295	270
NS151-1922	19*22	280	310	280
NS151-1924	19*24	310	355	320
NS151-2123	21*23	285	405	360
NS151-2126	21*26	320	450	410
NS151-2224	22*24	310	455	415
NS151-2427	24*27	340	520	475
NS151-2430	24*30	350	550	501
NS151-2528	25*28	350	580	530
NS151-2632	26*32	370	640	570
NS151-2730	27*30	360	705	645
NS151-3032	30*32	380	805	736
NS151-3036	30*36	395	1050	960
NS151-3234	32*34	400	1080	980
NS151-3236	32*36	405	1145	1030
NS151-3436	34*36	420	1165	1065
NS151-3641	36*41	445	1600	1465
NS151-4146	41*46	470	2077	1905
NS151-4650	46*50	490	2530	2315
NS151-5055	50*55	510	2580	2360
NS151-5060	50*60	520	3002	2745
NS151-5560	55*60	530	3203	2905
NS151-6070	60*70	560	4105	3605

**NS152** Wrench, Double Box Offset

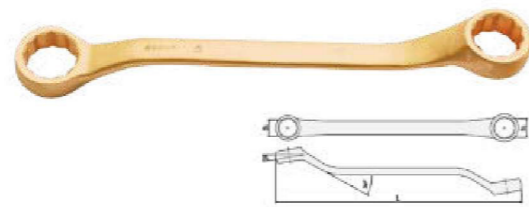

Item No.	S1*S2 (mm)	L (mm)	Beryllium Copper (g)	Aluminium Bronze (g)
NS152-0507	5,5*7	120	40	35
NS152-0607	6*7	122	45	40
NS152-0709	7*9	126	50	46
NS152-0810	8*10	130	55	50
NS152-0910	9*10	135	60	55
NS152-0911	9*11	140	70	65
NS152-1012	10*12	160	85	80
NS152-1013	10*13	164	90	85
NS152-1014	10*14	168	110	100
NS152-1113	11*13	172	110	105
NS152-1213	12*13	176	120	115
NS152-1214	12*14	180	125	110
NS152-1417	14*17	220	190	170
NS152-1618	16*18	240	230	205
NS152-1719	17*19	250	240	215
NS152-1819	18*19	268	295	270
NS152-1922	19*22	280	322	295
NS152-2022	20*22	292	365	330
NS152-2123	21*23	298	393	360
NS152-2224	22*24	310	450	415
NS152-2326	23*26	325	465	435
NS152-2427	24*27	340	520	476
NS152-2528	25*28	346	580	530
NS152-2730	27*30	360	705	645
NS152-3032	30*32	380	805	736
NS152-3234	32*34	398	890	800
NS152-3436	34*36	418	1070	960
NS152-3638	36*38	434	1200	1080
NS152-3641	36*41	450	1560	1400
NS152-4146	41*46	470	1840	1650
NS152-4650	46*50	490	2530	2314
NS152-5055	50*55	510	2580	2360

**NS152A** Wrench, Double Box Offset

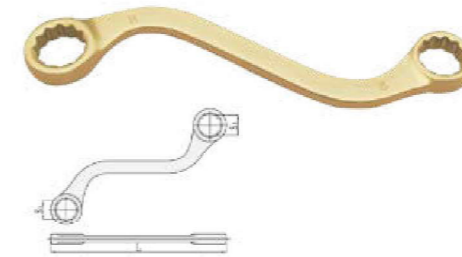

Item No.	S1*S2 (mm)	L (mm)	Beryllium Copper (g)	Aluminium Bronze (g)
NS152A-0607	6*7	90	45	40
NS152A-0709	7*9	90	55	50
NS152A-0810	8*10	100	80	70
NS152A-0911	9*11	100	90	80
NS152A-1012	10*12	110	125	110
NS152A-1214	12*14	125	160	140
NS152A-1417	14*17	140	230	200
NS152A-1719	17*19	170	310	270
NS152A-1922	19*22	185	420	370
NS152A-1924	19*24	185	450	400
NS152A-2123	21*23	185	490	430
NS152A-2126	21*26	185	500	435
NS152A-2224	22*24	210	670	600
NS152A-2326	23*26	210	670	600
NS152A-2427	24*27	225	720	640
NS152A-2430	24*30	225	740	650
NS152A-2528	25*28	225	750	670
NS152A-2730	27*30	250	870	780
NS152A-3032	30*32	275	1100	980

**NS153A** Wrench, Double Flat Box

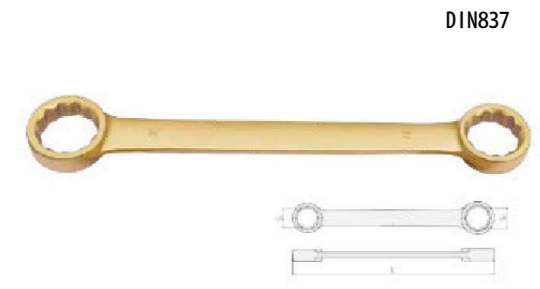

DIN837

Item No.	S1*S2 (mm)	L (mm)	Beryllium Copper (g)	Aluminium Bronze (g)
NS153A-0810	8*10	115	32	29
NS153A-0911	9*11	125	37	34
NS153A-1012	10*12	140	55	48
NS153A-1214	12*14	145	70	62
NS153A-1417	14*17	165	100	90
NS153A-1719	17*19	185	132	120
NS153A-1922	19*22	200	180	165
NS153A-2224	22*24	220	240	215
NS153A-2427	24*27	255	320	280
NS153A-2730	27*30	280	385	340
NS153A-3032	30*32	295	465	415
NS153A-3036	30*36	330	600	545
NS153A-3641	36*41	365	935	845

**NS153** Wrench, Double Box Offset



Item No.	S1*S2 (inch)	L (mm)	Beryllium Copper (g)	Aluminium Bronze (g)
NS153-1002	1/4*5/16	115	30	27
NS153-1004	5/16*3/8	125	45	40
NS153-1006	3/8*7/16	140	60	55
NS153-1008	7/16*1/2	155	90	80
NS153-1010	1/2*9/16	175	115	105
NS153-1012	9/16*5/8	215	190	170
NS153-1014	5/8*11/16	220	205	190
NS153-1016	11/16*3/4	245	235	215
NS153-1018	3/4*13/16	255	295	270
NS153-1020	13/16*7/8	275	350	320
NS153-1022	7/8*15/16	305	405	370
NS153-1024	15/16*1	310	490	375
NS153-1026	1*1-1/16	330	535	490
NS153-1028	1-1/16*1-1/8	330	570	520
NS153-1030	1-1/8*1-3/16	370	830	760
NS153-1032	1-3/16*1-1/4	370	835	765
NS153-1034	1-1/4*1-5/16	380	1020	935
NS153-1036	1-5/16*1-3/8	410	1050	960
NS153-1038	1-3/8*1-7/16	410	1425	1310
NS153-1040	1-7/16*1-5/8	450	1585	1450
NS153-1042	1-1/2*1-9/16	460	1803	1640
NS153-1044	1-5/8*1-13/16	470	2077	1905
NS153-1046	1-13/16*2	490	2530	2315
NS153-1048	2*2-3/16	510	2580	2360
NS153-1050	2*2-3/8	520	3002	2745
NS153-1052	2-3/16*2-3/8	530	3203	2905
NS153-1054	2-3/8*2-3/4	560	4105	3605

**NS153B** Flare Nut Open Ring Wrenches

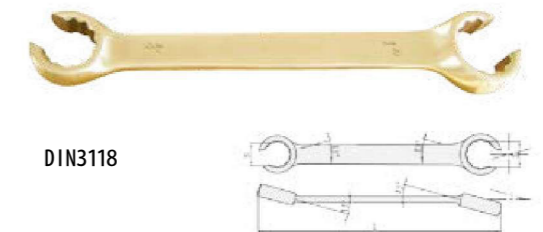

DIN3118

Item No.	S1*S2 (mm)	L (mm)	Beryllium Copper (g)	Aluminium Bronze (g)
NS153B-0607	6*7	95	17	15
NS153B-0810	8*10	115	32	29
NS153B-0911	9*11	125	37	34
NS153B-1012	10*12	140	55	48
NS153B-1214	12*14	145	70	62
NS153B-1415	14*15	155	90	80
NS153B-1417	14*17	165	100	90
NS153B-1618	16*18	170	127	115
NS153B-1719	17*19	185	132	120
NS153B-1922	19*22	200	180	165
NS153B-2224	22*24	220	240	215
NS153B-2427	24*27	255	320	288
NS153B-2430	24*30	270	375	340
NS153B-2528	25*28	265	380	345
NS153B-2730	27*30	280	430	389
NS153B-3032	30*32	295	498	450
NS153B-3034	30*34	310	588	535
NS153B-3036	30*36	330	657	595
NS153B-3436	34*36	345	758	685
NS153B-3641	36*41	365	935	845



**NS154** Wrench, Construction

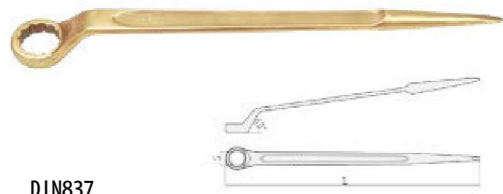

DIN837

Item No.	S (mm)	L (mm)	Beryllium Copper (g)	Aluminium Bronze (g)
NS154-10	10	230	90	85
NS154-12	12	250	110	105
NS154-14	14	270	145	130
NS154-17	17	310	200	180
NS154-19	19	330	250	225
NS154-22	22	350	320	290
NS154-24	24	370	400	360
NS154-27	27	400	500	450
NS154-30	30	430	700	630
NS154-32	32	430	660	600
NS154-36	36	460	900	800
NS154-41	41	490	1090	990
NS154-46	46	520	1560	1420
NS154-50	50	540	1700	1550
NS154-55	55	560	2050	1850
NS154-60	60	610	2820	2550

**NS156** Wrench, Single Box



Item No.	S (mm)	L (mm)	Beryllium Copper (g)	Aluminium Bronze (g)
NS156-8	8	110	40	35
NS156-10	10	120	50	45
NS156-12	12	130	65	60
NS156-14	14	140	90	80
NS156-17	17	155	105	90
NS156-19	19	170	130	95
NS156-22	22	190	175	150
NS156-24	24	215	220	200
NS156-27	27	230	270	245
NS156-30	30	255	370	335
NS156-32	32	265	425	385
NS156-36	36	295	550	500
NS156-41	41	330	825	750
NS156-46	46	365	1120	1010
NS156-50	50	400	1270	1150
NS156-55	55	445	1590	1440
NS156-60	60	474	1850	1680
NS156-65	65	510	2060	1875
NS156-70	70	555	2530	2300
NS156-75	75	590	2700	2450

**NS158** Wrench, Single Box Offset

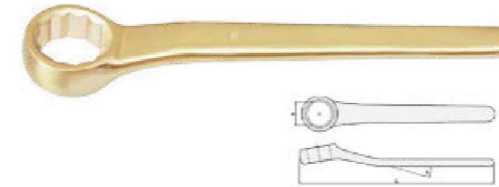

Item No.	S (mm)	L (mm)	Beryllium Copper (g)	Aluminium Bronze (g)
NS158-17	17	150	135	122
NS158-19	19	170	175	150
NS158-21	21	183	220	190
NS158-22	22	190	230	202
NS158-24	24	210	302	250
NS158-27	27	230	380	330
NS158-30	30	250	505	430
NS158-32	32	270	620	540
NS158-36	36	290	805	710

**NS159A** Wrench, Single Box Offset

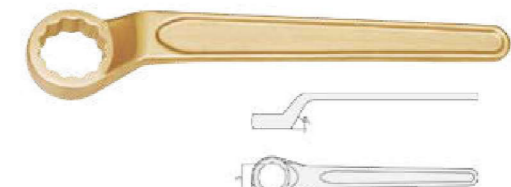

Item No.	S (mm)	L (mm)	Beryllium Copper (g)	Aluminium Bronze (g)
NS159A-22	22	190	185	165
NS159A-24	24	215	235	210
NS159A-27	27	230	310	270
NS159A-30	30	255	430	380
NS159A-32	32	265	450	400
NS159A-36	36	295	610	540
NS159A-41	41	330	855	770
NS159A-46	46	365	1000	900
NS159A-50	50	400	1350	1200
NS159A-55	55	445	2000	1800
NS159A-60	60	474	2260	2050
NS159A-65	65	510	2800	2500
NS159A-70	70	555	3250	2900
NS159A-75	75	590	3450	3090

**NS155** Wrench, Construction



Item No.	S (mm)	L (mm)	Beryllium Copper (g)	Aluminium Bronze (g)
NS155-8	8	140	60	55
NS155-10	10	150	70	64
NS155-11	11	160	80	73
NS155-12	12	170	90	83
NS155-13	13	180	102	91
NS155-14	14	190	115	102
NS155-15	15	200	125	110
NS155-16	16	210	130	122
NS155-17	17	220	165	145
NS155-18	18	230	180	165
NS155-19	19	240	230	195
NS155-20	20	250	242	220
NS155-21	21	260	251	230
NS155-22	22	270	303	274
NS155-23	23	280	330	302
NS155-24	24	290	361	330
NS155-27	27	320	472	430
NS155-30	30	350	650	585
NS155-32	32	370	680	620
NS155-34	34	380	803	730
NS155-36	36	390	950	850
NS155-38	38	400	1005	880
NS155-41	41	410	1430	1025
NS155-46	46	420	1460	1310
NS155-50	50	430	1580	1420
NS155-55	55	440	1870	1690
NS155-60	60	460	2330	2095
NS155-65	65	480	2802	2535
NS155-70	70	500	3150	2845

**NS157** Wrench, Single Bent Box

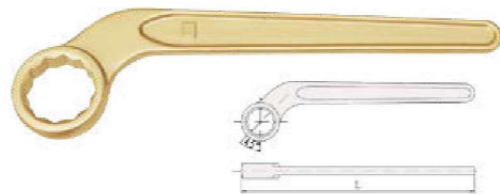

Item No.	S (mm)	L (mm)	Beryllium Copper (g)	Aluminium Bronze (g)
NS157-10	10	119	60	50
NS157-12	12	151	85	75
NS157-14	14	151	85	75
NS157-16	16	174	150	130
NS157-17	17	174	160	145
NS157-19	19	207	195	190
NS157-22	22	207	205	180
NS157-24	24	250	330	295
NS157-27	27	250	315	275
NS157-30	30	295	480	430
NS157-32	32	295	455	410
NS157-34	34	307	650	580
NS157-36	36	307	650	580
NS157-38	38	340	830	740
NS157-41	41	340	810	720
NS157-46	46	370	1230	1100
NS157-50	50	400	1400	1255
NS157-55	55	430	1930	1720
NS157-60	60	450	2100	1900
NS157-65	65	470	2360	2135
NS157-70	70	490	3080	2800
NS157-75	75	510	3600	3250
NS157-80	80	530	4460	4030

**NS159** Wrench, Single Box Offset



DIN3111

Item No.	S (mm)	L (mm)	Beryllium Copper (g)	Aluminium Bronze (g)
NS159-10	10	110	75	65
NS159-12	12	120	115	102
NS159-14	14	130	135	120
NS159-17	17	150	145	130
NS159-19	19	170	185	160
NS159-22	22	190	240	215
NS159-24	24	210	320	290
NS159-27	27	230	401	370
NS159-30	30	250	520	475
NS159-32	32	270	650	595
NS159-34	34	280	780	715
NS159-36	36	290	802	730

**NS165** Valve Square Driver

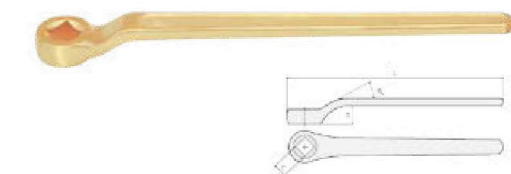

Item No.	C (mm)	L (mm)	H (mm)	Beryllium Copper (g)	Aluminium Bronze (g)
NS165-6	6	110	9	65	55
NS165-8	8	120	10	75	61
NS165-9	9	140	11	90	75
NS165-10	10	140	12	105	85
NS165-11	11	160	13	130	102
NS165-12	12	190	14	180	145
NS165-13	13	200	15	185	151
NS165-14	14	250	16	300	261
NS165-16	16	250	18	335	285
NS165-17	17	300	19	420	366
NS165-19	19	350	20	740	662
NS165-22	22	400	22	1000	896

### NS160 Wrench, Striking Box

DIN7444



Item No.	S (mm)	L (mm)	Beryllium Copper (g)	Aluminium Bronze (g)
NS160-17	17	145	210	190
NS160-19	19	145	200	180
NS160-22	22	155	245	220
NS160-24	24	165	235	210
NS160-27	27	175	350	315
NS160-30	30	185	475	430
NS160-32	32	185	465	420
NS160-34	34	200	540	490
NS160-36	36	205	580	520
NS160-38	38	215	680	620
NS160-41	41	225	755	680
NS160-46	46	235	990	890
NS160-50	50	250	1145	1030
NS160-55	55	265	1440	1300
NS160-60	60	274	1620	1450
NS160-65	65	298	1995	1800
NS160-70	70	320	2435	2200
NS160-75	75	326	3010	2720
NS160-80	80	350	3600	3250
NS160-85	85	355	4330	3915
NS160-90	90	380	5200	4700
NS160-95	95	390	5450	4920
NS160-100	100	410	6750	6100
NS160-105	105	420	7000	6320
NS160-110	110	445	9130	8250
NS160-120	120	480	11000	9930
NS160-130	130	510	12610	11400
NS160-140	140	520	13000	11750
NS160-150	150	565	14500	13100

### NS160A Wrench, Striking Box



Item No.	S (mm)	L (mm)	Beryllium Copper (g)	Aluminium Bronze (g)
NS160A-17	17	108	105	95
NS160A-19	19	117	135	125
NS160A-22	22	127	192	185
NS160A-24	24	138	270	250
NS160A-27	27	150	350	320
NS160A-30	30	163	460	420
NS160A-32	32	177	610	555
NS160A-34	34	192	690	630
NS160A-36	36	208	780	710
NS160A-38	38	215	875	805
NS160A-41	41	225	985	902
NS160A-46	46	243	1275	1160
NS160A-50	50	254	1545	1410
NS160A-55	55	264	1720	1560
NS160A-60	60	275	2080	1880
NS160A-65	65	286	2440	2202
NS160A-70	70	298	2735	2470
NS160A-75	75	311	3190	2905
NS160A-80	80	325	3485	3160
NS160A-85	85	339	3990	3650
NS160A-90	90	355	4350	3960
NS160A-95	95	370	5046	4560
NS160A-100	100	387	5630	5125
NS160A-105	105	405	6250	5690
NS160A-110	110	410	6750	6100
NS160A-120	120	425	7405	6735
NS160A-130	130	450	7905	7205
NS160A-140	140	465	8105	7405

### NS162B Wrench, Offset Striking Box

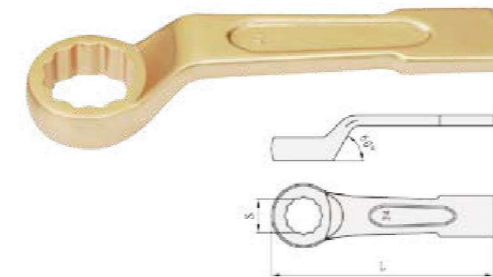

Item No.	S (mm)	L (mm)	Beryllium Copper (g)	Aluminium Bronze (g)
NS162B-24	24	160	370	335
NS162B-27	27	180	475	430
NS162B-30	30	200	615	555
NS162B-32	32	200	615	555
NS162B-36	36	220	825	745
NS162B-41	41	240	950	860
NS162B-46	46	250	1330	1200
NS162B-50	50	270	1650	1450
NS162B-55	55	295	2000	1800
NS162B-60	60	317	2430	2200
NS162B-65	65	330	2750	2490
NS162B-70	70	350	3385	3060
NS162B-75	75	370	4655	4205
NS162B-80	80	385	5020	4540

### NS163A Offset Slogging Box Wrench (American Type)

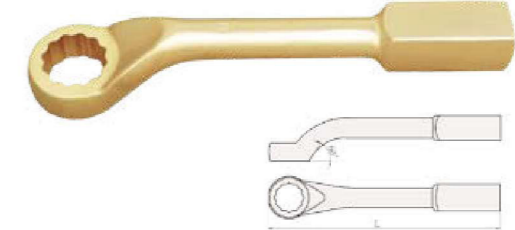

Item No.	S (mm)	L (mm)	Beryllium Copper (g)	Aluminium Bronze (g)
NS163A-24	24	240	950	860
NS163A-27	27	270	1150	1035
NS163A-30	30	280	1480	1340
NS163A-32	32	290	1690	1530
NS163A-36	36	300	1900	1720
NS163A-41	41	320	2110	1910
NS163A-46	46	340	2750	2485
NS163A-50	50	350	3170	2870
NS163A-55	55	360	4125	3730
NS163A-60	60	375	4335	3920
NS163A-65	65	390	4440	4010
NS163A-70	70	400	5400	4875
NS163A-75	75	420	5810	5255
NS163A-80	80	440	7295	6600
NS163A-90	90	480	9740	8800
NS163A-100	100	515	11300	10200
NS163A-110	110	550	13400	12100
NS163A-120	120	585	15500	14000
NS163A-130	130	620	17700	16000

### NS161 Wrench, Striking Box



DIN7444

Item No.	S (inch)	L (mm)	Beryllium Copper (g)	Aluminium Bronze (g)
NS161-1002	11/16	145	210	190
NS161-1004	3/4	145	200	180
NS161-1006	7/8	155	245	220
NS161-1008	1	175	350	315
NS161-1010	1-1/16	175	350	315
NS161-1012	1-1/8	185	455	410
NS161-1014	1-3/16	185	475	430
NS161-1016	1-1/4	185	470	425
NS161-1018	1-3/8	200	560	500
NS161-1020	1-1/2	215	790	710
NS161-1022	1-5/8	225	755	680
NS161-1024	1-3/4	235	1020	920
NS161-1026	1-13/16	235	990	890
NS161-1028	2	250	1145	1030

### NS162 Wrench, Striking Box



Item No.	S (mm)	L (mm)	Beryllium Copper (g)	Aluminium Bronze (g)
NS162-32	32	180	790	710
NS162-36	36	190	990	900
NS162-41	41	200	1450	1300
NS162-46	46	210	1770	1600
NS162-50	50	230	1930	1730
NS162-55	55	260	3400	3060
NS162-60	60	290	4200	3800
NS162-65	65	320	5430	4900
NS162-70	70	350	6480	5850
NS162-75	75	380	7890	7130
NS162-80	80	410	10350	9350

### NS163 Wrench, Striking Convex Box



Item No.	S (mm)	L (mm)	Beryllium Copper (g)	Aluminium Bronze (g)
NS163-22	22	165	230	210
NS163-24	24	165	220	300
NS163-27	27	175	370	335
NS163-30	30	185	530	480
NS163-32	32	185	475	430
NS163-36	36	210	740	670
NS163-41	41	227	950	860
NS163-46	46	245	1270	1145
NS163-50	50	257	1590	1435
NS163-55	55	267	1800	1625
NS163-60	60	278	2115	1910
NS163-65	65	298	2580	2340
NS163-70	70	320	2960	2680
NS163-75	75	326	3350	3000

### NS164 Wrench, Striking Box Bent

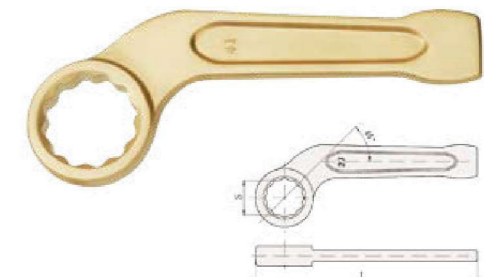

Item No.	S (mm)	L (mm)	Beryllium Copper (g)	Aluminium Bronze (g)
NS164-24	24	160	280	240
NS164-27	27	175	370	335
NS164-30	30	190	525	475
NS164-32	32	190	500	450
NS164-36	36	210	630	570
NS164-41	41	225	750	650
NS164-46	46	240	1160	1030
NS164-50	50	255	1240	1100
NS164-55	55	270	1450	1285
NS164-60	60	285	1820	1640
NS164-65	65	300	2645	2390
NS164-70	70	320	2960	2675



### NS162A Wrench, Offset Striking Box

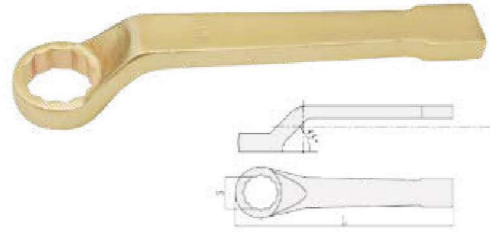

Item No.	S (mm)	L (mm)	Beryllium Copper (g)	Aluminium Bronze (g)
NS162A-27	27	245	670	600
NS162A-30	30	270	970	870
NS162A-32	32	270	970	870
NS162A-36	36	280	1060	950
NS162A-41	41	305	1430	1280
NS162A-46	46	310	1830	1640
NS162A-50	50	320	2100	1890
NS162A-55	55	320	2350	2110
NS162A-60	60	355	2900	2610
NS162A-65	65	380	3470	3120
NS162A-70	70	400	4050	3640
NS162A-75	75	420	4350	4180
NS162A-80	80	435	5500	4950
NS162A-85	85	440	6500	5850
NS162A-90	90	445	6820	6320
NS162A-95	95	450	7880	7000
NS162A-100	100	455	7900	7130
NS162A-110	110	460	8400	7590
NS162A-120	120	470	8900	8040

### NS164B Crow Foot Box End

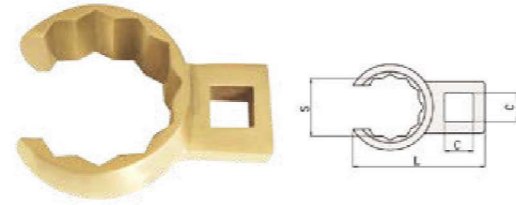

Item No.	C (inch)	S (inch)	L (mm)	Beryllium Copper (g)	Aluminium Bronze (g)
NS164B-1002	3/8	7/16	29	35	30
NS164B-1004	3/8	1/2	31	40	35
NS164B-1006	3/8	9/16	33	45	40
NS164B-1008	3/8	5/8	38	50	45
NS164B-1010	3/8	11/16	41	55	50
NS164B-1012	3/8	3/4	43	55	50
NS164B-1014	1/2	7/8	48	80	70
NS164B-1016	1/2	1	52	85	75
NS164B-1018	1/2	1-1/16	54	90	80
NS164B-1020	1/2	1-1/8	56	100	90
NS164B-1022	1/2	1-1/4	62	145	130
NS164B-1024	1/2	1-5/16	66	170	150
NS164B-1026	1/2	1-1/2	72	190	170
NS164B-1028	1/2	1-5/8	76	210	180
NS164B-1030	1/2	2	89	230	200

### NS166 Wrench, Hex Key

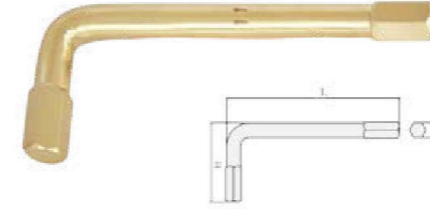

Item No.	S (mm)	L (mm)	H (mm)	Beryllium Copper (g)	Aluminium Bronze (g)
NS166-1,5	1,5	38	13	6	5
NS166-2	2	38	13	6	5
NS166-2,5	2,5	38	13	6	5
NS166-3	3	59	25	8	7
NS166-4	4	65	30	10	8
NS166-5	5	79	32	16	12
NS166-6	6	85	37	25	20
NS166-7	7	88	43	34	30
NS166-8	8	92	44	50	45
NS166-9	9	97	44	61	55
NS166-10	10	110	45	82	70
NS166-11	11	119	48	100	90
NS166-12	12	130	52	145	130
NS166-13	13	140	54	180	160
NS166-14	14	150	58	211	191
NS166-15	15	156	60	260	230
NS166-16	16	162	63	300	270
NS166-17	17	168	65	370	335
NS166-18	18	173	69	450	402
NS166-19	19	177	72	490	445
NS166-21	21	184	74	652	595
NS166-22	22	186	77	675	615
NS166-24	24	192	82	825	755
NS166-25	25	200	84	925	840
NS166-26	26	206	90	1025	940
NS166-27	27	213	93	1220	1115
NS166-28	28	222	95	1350	1235
NS166-30	30	240	105	1615	1475
NS166-32	32	266	116	2065	1885
NS166-36	36	294	128	2905	2650
NS166-41	41	320	140	4120	3760

### NS167A Wrench, Hex Key With Ball

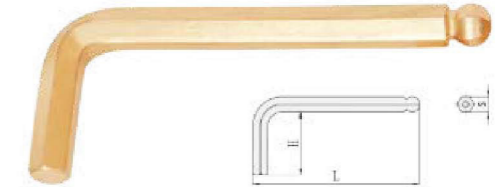

Item No.	S (mm)	L (mm)	H (mm)	Beryllium Copper (g)	Aluminium Bronze (g)
NS167A-2	2	50	16	3	2
NS167A-3	3	63	20	5	4
NS167A-4	4	70	25	12	11
NS167A-5	5	80	28	22	20
NS167A-6	6	90	32	30	27
NS167A-7	7	95	34	50	45
NS167A-8	8	100	36	56	51
NS167A-9	9	106	38	85	76
NS167A-10	10	112	40	100	90
NS167A-11	11	118	42	140	125
NS167A-12	12	125	45	175	160

### NS164A Ring Wrench For Extension

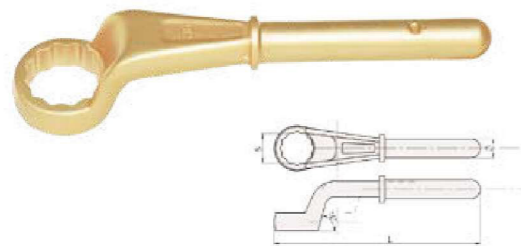

Item No.	S (mm)	L (mm)	Beryllium Copper (g)	Aluminium Bronze (g)
NS164A-24	24	180	475	430
NS164A-27	27	190	530	480
NS164A-30	30	200	580	525
NS164A-32	32	235	795	715
NS164A-36	36	245	900	815
NS164A-41	41	265	1060	955
NS164A-46	46	280	1480	1340
NS164A-50	50	290	1690	1530
NS164A-55	55	300	1850	1670
NS164A-60	60	345	2960	2670
NS164A-65	65	355	3380	3055
NS164A-70	70	365	3910	3530
NS164A-75	75	375	4335	3920
NS164A-80	80	385	5180	4680

### Extension For NS164A



Item No.	Φ (mm)	L (mm)	Beryllium Copper (g)	Aluminium Bronze (g)
NS24-30	19	460	940	850
NS32-41	22	610	1640	1480
NS46-55	25	760	2480	2240
NS60-80	30	860	3890	3515



Item No.	Φ (mm)	L (mm)	Copper (g)	Brass (g)
NS24-30	19	460	880	830
NS32-41	22	610	1280	1210
NS46-55	25	760	2125	2005
NS60-80	30	860	3265	3080

### NS167 Wrench, Hex Key

Item No.	S (inch)	L (mm)	H (mm)	Beryllium Copper (g)	Aluminium Bronze (g)
NS167-1002	1/16	38	13	6	5
NS167-1004	5/64	38	13	6	5
NS167-1006	3/32	38	13	6	5
NS167-1008	7/64	58	24	8	5
NS167-1010	1/8	58	24	8	6
NS167-1012	9/64	64	29	8	7
NS167-1014	5/32	65	30	10	9
NS167-1016	3/16	79	31	15	14
NS167-1018	7/32	85	37	20	18
NS167-1020	1/4	85	37	30	27
NS167-1022	9/32	88	43	45	40
NS167-1024	5/16	92	44	48	44
NS167-1026	11/32	97	44	50	45
NS167-1028	3/8	110	45	85	80
NS167-1030	7/16	119	48	110	100
NS167-1032	1/2	140	55	170	155
NS167-1034	9/16	150	58	195	180
NS167-1036	5/8	162	63	270	245
NS167-1038	11/16	168	65	355	325
NS167-1040	3/4	178	73	450	415
NS167-1042	13/16	184	77	565	520
NS167-1044	7/8	187	79	650	595
NS167-1046	15/16	192	82	825	755
NS167-1048	1	200	85	925	840
NS167-1050	1-1/16	213	93	1220	1115

### NS167B Wrench, Hex Key

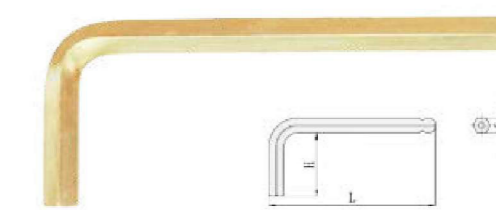

Item No.	S (mm)	L (mm)	H (mm)	Beryllium Copper (g)	Aluminium Bronze (g)
NS167B-2	2	50	16	3	2
NS167B-3	3	63	20	5	4
NS167B-4	4	70	25	12	11
NS167B-5	5	80	28	22	20
NS167B-6	6	90	32	30	27
NS167B-7	7	95	34	50	45
NS167B-8	8	100	36	56	50
NS167B-9	9	106	38	85	77
NS167B-10	10	112	40	100	90
NS167B-11	11	118	42	140	126
NS167B-12	12	125	45	162	145

**NS167C** Wrench, T Type Hex Key

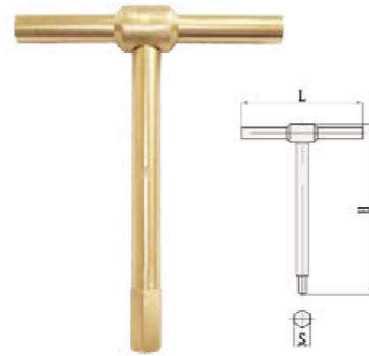

Item No.	S (mm)	L (mm)	H (mm)	Beryllium Copper (g)	Aluminium Bronze (g)
NS167C-2	2	90	100	55	50
NS167C-3	3	90	100	55	50
NS167C-4	4	90	100	75	70
NS167C-5	5	90	100	85	75
NS167C-6	6	90	100	100	90
NS167C-8	8	90	100	100	90
NS167C-10	10	90	100	150	135

**NS168** Valve Wrench, C Type

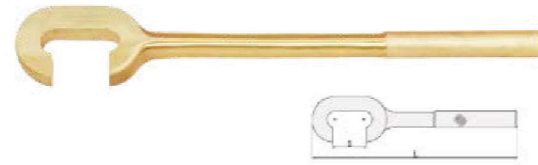

Item No.	L (mm)	S (mm)	Beryllium Copper (g)	Aluminium Bronze (g)
NS168-1002	450	40	1205	1102

**NS169** Valve Wrench, C Type

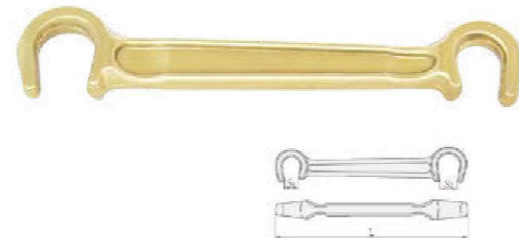

Item No.	L (mm)	S1 (mm)	S2 (mm)	Beryllium Copper (g)	Aluminium Bronze (g)
NS169-1002	200	14,5	18,5	370	335
NS169-1004	250	17,5	25,5	635	575
NS169-1006	450	25,5	34	2385	2160

**NS170** Valve Wrench, C Type

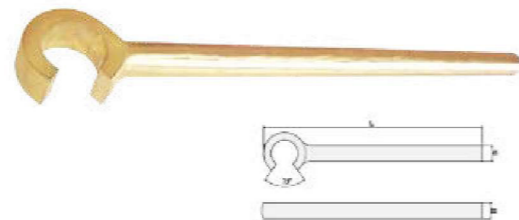

Item No.	L (mm)	Φ (mm)	H (mm)	Beryllium Copper (g)	Aluminium Bronze (g)
NS170-1002	600	32	32	4500	4115

**NS170A** Valve Spanner (U Type)

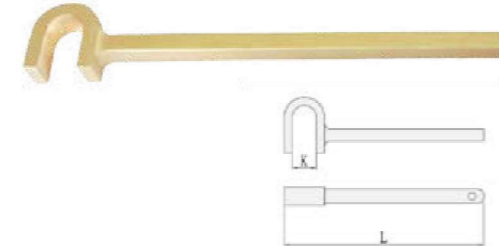

Item No.	L (mm)	K <sub>max</sub> (mm)	Beryllium Copper (g)	Aluminium Bronze (g)
NS170A-1002	234	20	260	235
NS170A-1004	280	30	820	740
NS170A-1006	335	35	980	885
NS170A-1008	400	35	1640	1480

**NS170B** Valve Spanner (U Type)

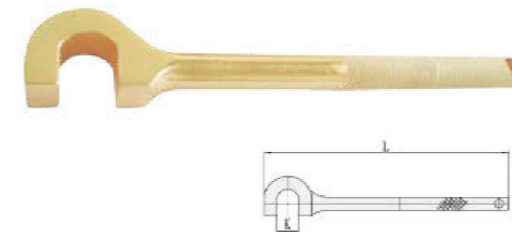

Item No.	L (mm)	K <sub>max</sub> (mm)	Beryllium Copper (g)	Aluminium Bronze (g)
NS170B-1002	226	20	370	335

**NS171** Oxygen Bottle Wrench

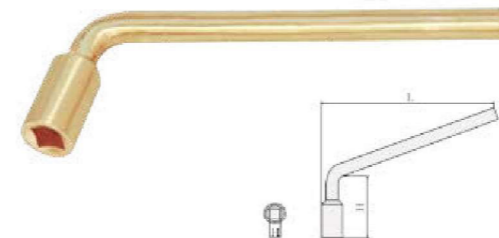

Item No.	C (inch)	L (mm)	H (mm)	Beryllium Copper (g)	Aluminium Bronze (g)
NS171-1002	3/8	154	58	185	170

**NS172** Wrench, T-type Sliding Hex

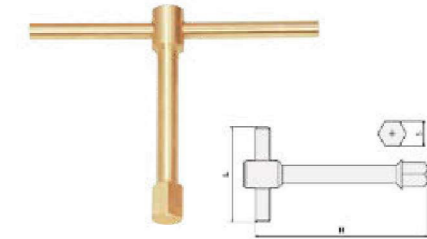

Item No.	S (mm)	L (mm)	H (mm)	Beryllium Copper (g)	Aluminium Bronze (g)
NS172-10	10	150	110	270	245
NS172-12	12	170	130	290	265
NS172-14	14	170	140	400	365
NS172-17	17	190	150	465	423
NS172-19	19	220	160	615	563
NS172-22	22	240	170	660	605
NS172-24	24	260	180	935	855
NS172-27	27	260	190	1000	915
NS172-30	30	280	200	1306	1195
NS172-32	32	280	210	1505	1375
NS172-36	36	300	216	1802	1645
NS172-41	41	300	226	2075	1895

**NS173** Wrench, Hook

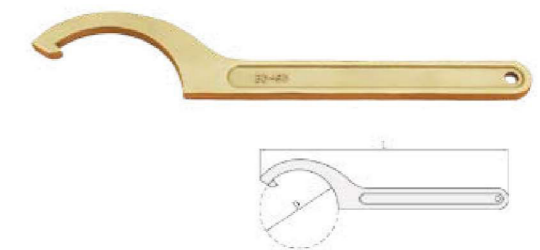

DIN1810

Item No.	D (mm)	L (mm)	Beryllium Copper (g)	Aluminium Bronze (g)
NS173-1002	30-32	140	63	50
NS173-1004	34-36	170	95	85
NS173-1006	40-42	176	105	95
NS173-1008	45-50	209	160	145
NS173-1010	52-55	212	170	150
NS173-1012	58-62	144	225	200
NS173-1014	68-75	250	265	240
NS173-1016	80-90	284	375	335
NS173-1018	95-100	288	415	370
NS173-1020	110-115	337	770	690
NS173-1022	120-130	343	770	690
NS173-1024	135-145	388	1110	1000



### NS173A Wrench, Hook



Item No.	D (mm)	L (mm)	Beryllium Copper (g)	Aluminium Bronze (g)
NS173A-1002	118	280	350	310

### NS173B Wrench, Adjustable Hook



Item No.	D (mm)	L (mm)	Beryllium Copper (g)	Aluminium Bronze (g)
NS173B-1002	19-50	162	120	110
NS173B-1004	32-75	205	260	235
NS173B-1006	50-120	288	515	460
NS173B-1008	115-170	310	670	600

### NS173C Hook Wrench With Pin



Item No.	D (mm)	L (mm)	Beryllium Copper (g)	Aluminium Bronze (g)
NS173C-1002	30-32	140	63	50
NS173C-1004	34-36	170	95	85
NS173C-1006	40-42	176	105	95
NS173C-1008	45-50	209	160	145
NS173C-1010	52-55	212	170	150
NS173C-1012	58-62	244	225	200
NS173C-1014	68-75	250	265	240
NS173C-1016	80-90	284	375	335
NS173C-1018	95-100	288	415	370
NS173C-1020	110-115	337	770	690

### NS174 Valve Handle

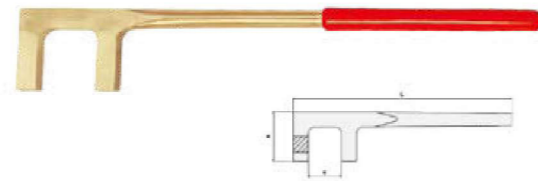

Item No.	S (mm)	L (mm)	H (mm)	Beryllium Copper (g)	Aluminium Bronze (g)
NS174-30	30	200	44	405	340
NS174-35	35	250	49	465	410
NS174-40	40	300	50	595	540
NS174-45	45	350	61	835	762
NS174-48	48	375	62	865	790
NS174-50	50	400	67	892	815
NS174-55	55	450	73	1270	1110
NS174-60	60	500	79	1570	1435
NS174-65	65	550	80	1920	1755
NS174-70	70	600	80	1945	1775
NS174-75	75	650	85	2245	2055
NS174-80	80	700	91	2405	2190
NS174-85	85	750	97	3050	2770
NS174-90	90	800	103	3360	3060
NS174-93	93	850	107	3553	3250
NS174-96	96	900	110	3870	3515
NS174-100	100	1000	114	4170	3795
NS174-103	103	1200	120	6330	5765

### NS174A Valve Handle

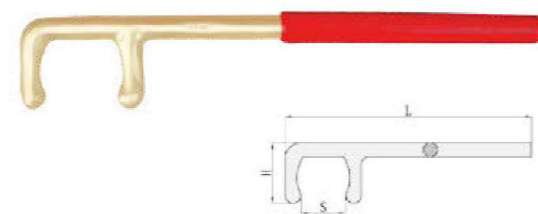

Item No.	S (mm)	L (mm)	H (mm)	Beryllium Copper (g)	Aluminium Bronze (g)
NS174A-30	30	200	46	265	240
NS174A-35	35	250	52	375	340
NS174A-40	40	300	54	450	400
NS174A-45	45	350	60	585	530
NS174A-50	50	400	68	740	670
NS174A-55	55	450	74	830	750
NS174A-60	60	500	80	1200	1100
NS174A-65	65	550	83	1280	1160
NS174A-70	70	600	88	1380	1250
NS174A-75	75	650	93,5	1650	1500
NS174A-80	80	700	99,5	1870	1700
NS174A-85	85	750	100	2090	1900
NS174A-90	90	800	107	2310	2100
NS174A-95	95	900	112	2980	2700
NS174A-100	100	1000	117	3330	3010

### NS174B Valve Handle



Item No.	S (mm)	L (mm)	H (mm)	Beryllium Copper (g)	Aluminium Bronze (g)
NS174B-30	30	200	46	265	240
NS174B-35	35	250	52	375	340
NS174B-40	40	300	54	450	400
NS174B-45	45	350	60	585	530
NS174B-50	50	400	68	740	670
NS174B-55	55	450	74	830	750
NS174B-60	60	500	80	1200	1100
NS174B-65	65	550	83	1280	1160
NS174B-70	70	600	88	1380	1250
NS174B-75	75	650	93,5	1650	1500
NS174B-80	80	700	99,5	1870	1700
NS174B-85	85	750	100	2090	1900
NS174B-90	90	800	107	2310	2100
NS174B-95	95	900	112	2980	2700
NS174B-100	100	1000	117	3330	3010

### NS176 Valve Handle

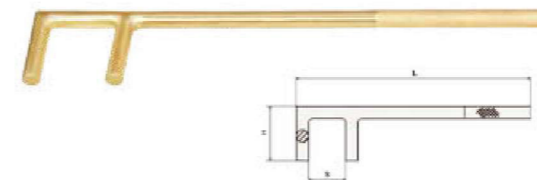

Item No.	S (mm)	L (mm)	H (mm)	Beryllium Copper (g)	Aluminium Bronze (g)
NS176-30	30	200	44	280	250
NS176-32	32	300	50	540	490
NS176-35	35	250	47	364	325
NS176-40	40	300	50	470	422
NS176-45	45	350	58	610	540
NS176-48	48	375	62	660	595
NS176-50	50	400	67	705	615
NS176-55	55	450	73	960	870
NS176-60	60	500	79	1205	1105
NS176-65	65	550	82	1370	1250
NS176-70	70	600	85	1540	1360
NS176-75	75	650	88	1705	1540
NS176-80	80	700	91	1910	1650
NS176-85	85	750	97	2250	2015
NS176-90	90	800	103	2380	2130

### NS175 Valve Handle

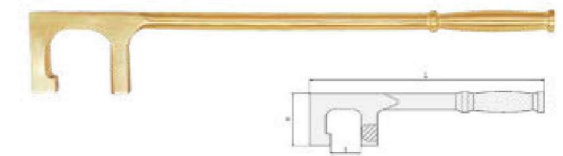

Item No.	S (mm)	L (mm)	H (mm)	Beryllium Copper (g)	Aluminium Bronze (g)
NS175-22	22	200	50	390	345
NS175-28	28	250	53	550	475
NS175-34	34	300	56	722	615
NS175-39	39	350	60	905	780
NS175-44	44	400	64	1050	910
NS175-48	48	450	69	1260	1130
NS175-53	53	500	74	1405	1250
NS175-58	58	550	79	1890	1720
NS175-63	63	600	84	2220	2005

### NS176A Valve Spanner

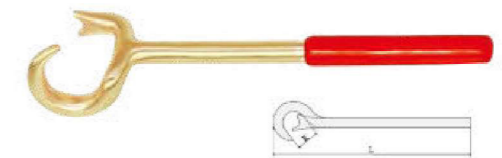

Item No.	K (mm)	L (mm)	Beryllium Copper (g)	Aluminium Bronze (g)
NS176A-1002	40	355	915	825

### NS176B Valve Spanner

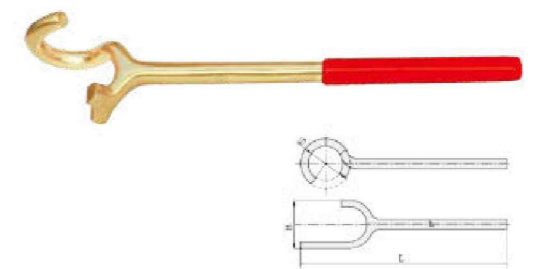

Item No.	B (mm)	Φ (mm)	L (mm)	Beryllium Copper (g)	Aluminium Bronze (g)
NS176B-1002	60	36	370	730	650
NS176B-1004	80	48	430	1520	1350
NS176B-1006	102	62	550	2250	2000

**NS176C** Valve Spanner

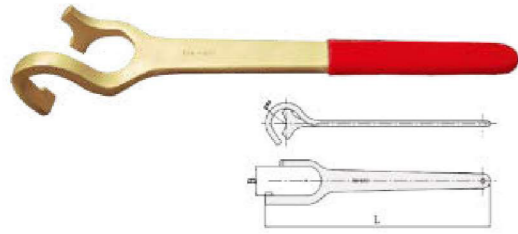

Item No.	B (mm)	R (mm)	L (mm)	Beryllium Copper (g)	Aluminium Bronze (g)
NS176C-1002	30	15	250	415	375
NS176C-1004	40	20	300	540	485
NS176C-1006	50	25	400	1050	950
NS176C-1008	60	30	550	1800	1630
NS176C-1010	130	65	750	4900	4430

**NS176F** Valve Spanner

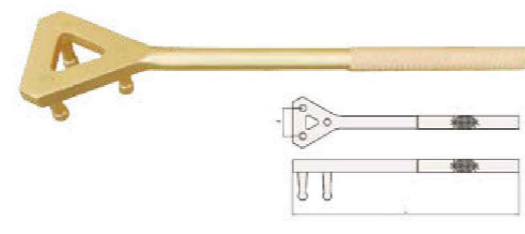

Item No.	L (mm)	A (mm)	Beryllium Copper (g)	Aluminium Bronze (g)
NS176F-200	200	25	220	200
NS176F-250	250	35	375	340
NS176F-300	300	42	440	400
NS176F-350	350	62	660	600
NS176F-400	400	90	1030	940
NS176F-450	450	110	1430	1300
NS176F-500	500	165	2090	1900
NS176F-550	550	225	2420	2200

**NS179** Wrench, Bung

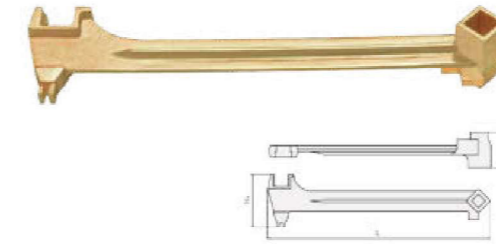

Item No.	L (mm)	H1 (mm)	H2 (mm)	Beryllium Copper (g)	Aluminium Bronze (g)
NS179-1002	385	93	61	1250	1150

**NS179C** Drum Opener



Item No.	Size	Beryllium Copper (g)	Aluminium Bronze (g)
NS179C-1002	NS-200	3100	2800

**NS176D** Valve Spanner

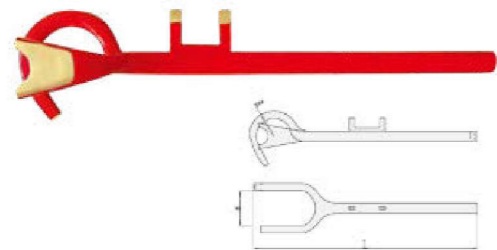

Item No.	B (mm)	R (mm)	L (mm)	Beryllium Copper (g)	Aluminium Bronze (g)
NS176D-1002	50	22,5	290	775	700
NS176D-1004	60	35,5	430	1770	1580
NS176D-1006	80	40	520	2770	2500
NS176D-1008	90	45	660	4080	3660

**NS177** Wrench, Bung

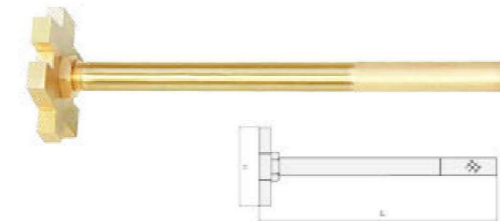

Item No.	L (mm)	H (mm)	Beryllium Copper (g)	Aluminium Bronze (g)
NS177-1002	300	70	630	580

**NS179A** Wrench, Bung

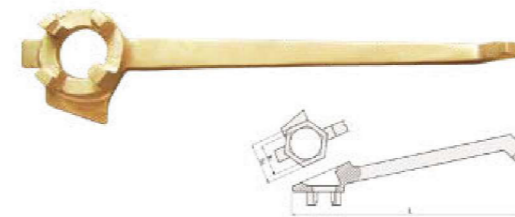

Item No.	L (mm)	S1 (mm)	S2 (mm)	Beryllium Copper (g)	Aluminium Bronze (g)
NS179A-1002	300	38	52	830	750

**NS180** Ratchet Wrench

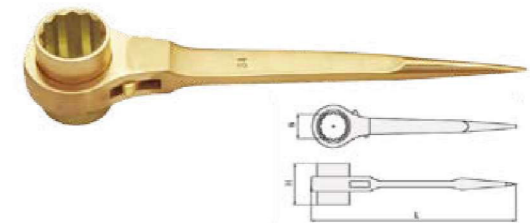

Item No.	S (mm)	L (mm)	H (mm)	Beryllium Copper (g)	Aluminium Bronze (g)
NS180-22	22	270	50	580	520
NS180-24	24	280	53	620	560
NS180-27	27	290	56	730	660
NS180-30	30	300	58	800	720
NS180-32	32	310	60	900	810
NS180-36	36	320	65	1000	900
NS180-38	38	320	65	1150	1030
NS180-41	41	330	70	1500	1350

**NS176E** Valve Spanner

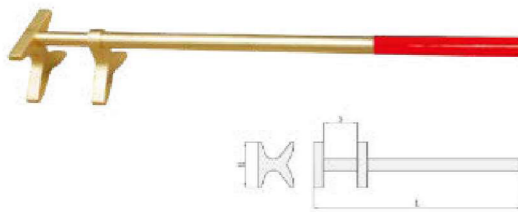

Item No.	S (mm)	H (mm)	L (mm)	Beryllium Copper (g)	Aluminium Bronze (g)
NS176E-1002	40	50	300	590	540
NS176E-1004	55	74	450	1165	1050
NS176E-1006	70	80	600	1950	1700
NS176E-1008	90	100	800	2800	2600

**NS178** Wrench, Bung

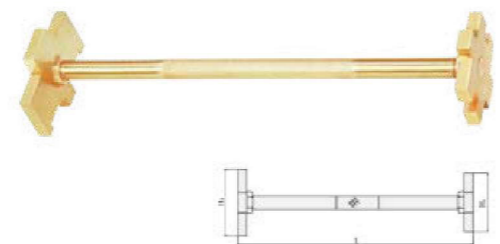

Item No.	L (mm)	H1 (mm)	H2 (mm)	Beryllium Copper (g)	Aluminium Bronze (g)
NS178-1002	350	70	95	1165	1070

**NS179B** Wrench, Bung

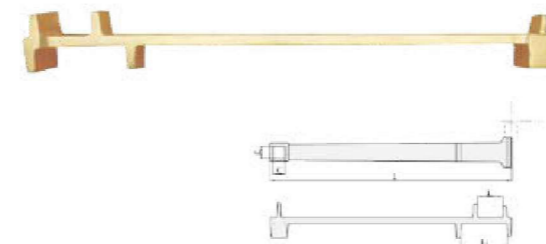

Item No.	L (mm)	C (mm)	K1 (mm)	K2 (mm)	Beryllium Copper (g)	Aluminium Bronze (g)
NS179B-1002	520	19	40	73	1120	1100

**NS180A** Ratchet Wrench



Item No.	S1 (mm)	S2 (mm)	L (mm)	Beryllium Copper (g)	Aluminium Bronze (g)
NS180A-1417	14	17	280	410	370
NS180A-1719	17	19	310	450	410
NS180A-1922	19	22	345	530	480
NS180A-2224	22	24	365	680	620
NS180A-2427	24	27	380	860	780
NS180A-2730	27	30	400	990	900
NS180A-3032	30	32	400	1025	930
NS180A-3236	32	36	450	1450	1300
NS180A-3641	36	41	495	1860	1690

### NS180B Ratchet Wrench



Item No.	S (mm)	L (mm)	Beryllium Copper (g)	Aluminium Bronze (g)
NS180B-22	22	400-650	1700	1550
NS180B-24	24	450-700	2000	1820
NS180B-27	27	500-750	2500	2280
NS180B-30	30	535-800	3000	2730
NS180B-32	32	535-800	3150	2870
NS180B-36	36	580-880	3350	3000
NS180B-41	41	600-900	3600	3280

### NS182 Ratchet Wrench

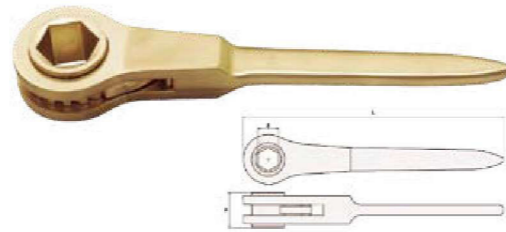

Item No.	S (mm)	L (mm)	H (mm)	Beryllium Copper (g)	Aluminium Bronze (g)
NS182-17	17	230	35	725	621
NS182-19	19	240	35	745	652
NS182-21	21	250	38	942	831
NS182-22	22	260	38	963	835
NS182-24	24	270	39	1175	1022
NS182-26	26	280	39	1221	1053
NS182-27	27	285	39	1253	1102
NS182-30	30	300	42	1532	1325
NS182-32	32	315	42	1622	1427
NS182-35	35	325	43	1821	1633
NS182-36	36	330	43	1829	1673
NS182-41	41	330	45	2129	1948

### NS181 Ratchet Wrench

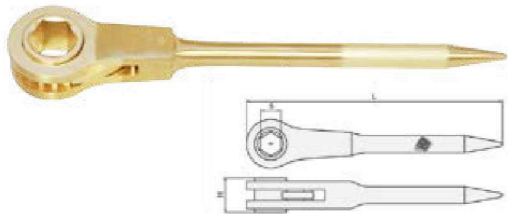

Item No.	S (mm)	L (mm)	H (mm)	Beryllium Copper (g)	Aluminium Bronze (g)
NS181-17	17	290	35	720	650
NS181-19	19	300	35	850	750
NS181-22	22	320	38	995	890
NS181-24	24	329	39	1230	1100
NS181-27	27	380	39	1500	1350
NS181-30	30	433	42	1900	1600
NS181-32	32	435	42	1935	1700
NS181-36	36	487	43	2580	2320

### NS183A Ratchet Wrench

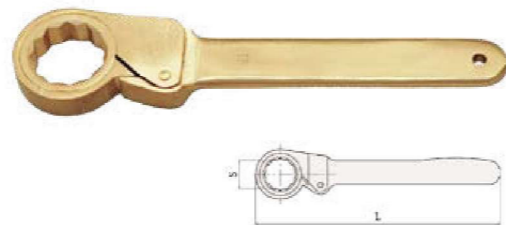

Item No.	S (mm)	L (mm)	Beryllium Copper (g)	Aluminium Bronze (g)
NS183A-9	9	150	125	110
NS183A-11	11	150	125	110
NS183A-13	13	155	160	140
NS183A-14	14	155	160	140
NS183A-17	17	200	260	230
NS183A-19	19	200	260	230
NS183A-22	22	220	340	300
NS183A-24	24	220	340	300
NS183A-27	27	245	560	500
NS183A-30	30	280	840	750
NS183A-32	32	280	840	750
NS183A-36	36	290	1180	1050
NS183A-41	41	295	1230	1100
NS183A-46	46	360	2060	1850
NS183A-50	50	360	2230	2000
NS183A-55	55	440	2900	2600
NS183A-60	60	440	2900	2600

### NS183 Ratchet Wrench



Item No.	S (mm)	L (mm)	H (mm)	Beryllium Copper (g)	Aluminium Bronze (g)
NS183-17	17	250	35	710	650
NS183-19	19	250	42	896	820
NS183-21	21	250	42	1030	940
NS183-22	22	250	42	1105	1010
NS183-24	24	250	48	1345	1230
NS183-26	26	250	48	1365	1250
NS183-27	27	250	48	1580	1450
NS183-30	30	250	53	1795	1640
NS183-32	32	250	53	1990	1820
NS183-35	35	250	60	2010	1840
NS183-36	36	250	60	2225	2035

### NS184 Hammer, Bricklayers'

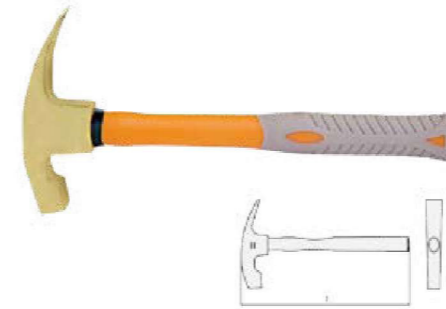

Item No.	H (g)	L (mm)	ΦT <sub>2</sub> (g)
NS184-1002	600	305	750
NS184-1004	800	340	1000

### NS186 Hammer, Cross Pein Engineers' DIN1041



Item No.	H (g)	L (mm)	ΦT <sub>2</sub> (g)
NS186-1002	500	310	655
NS186-1004	1000	340	1175
NS186-1006	1500	400	1850
NS186-1008	2000	450	2455
NS186-1010	3000	700	3700
NS186-1012	5000	900	6000

### NS185 Hammer, Claw



Item No.	H (g)	L (mm)	ΦT <sub>2</sub> (g)
NS185-1002	230	280	405
NS185-1004	450	300	652
NS185-1006	680	330	953
NS185-1008	910	390	1205

### NS187 Hammer, Ball Pein

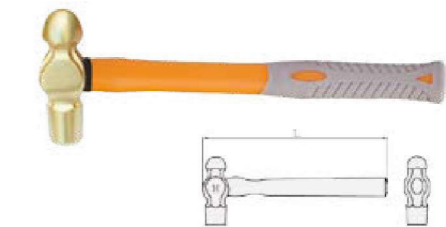

Item No.	H (g)	L (mm)	ΦT <sub>2</sub> (g)
NS187-1002	230	280	403
NS187-1004	340	280	502
NS187-1006	450	310	680
NS187-1008	680	340	950
NS187-1010	910	350	1205
NS187-1012	1130	400	1470

### NS185A Carpenter's Hammer

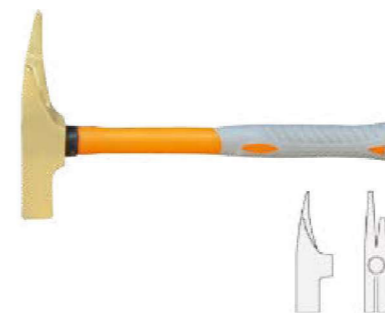

Item No.	H (g)	L (mm)	ΦT <sub>2</sub> (g)
NS185A-1002	500	300	700
NS185A-1004	600	330	870

### NS187A Hammer, Ball Pein

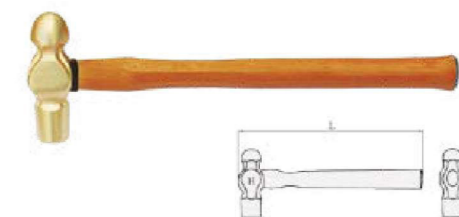

Item No.	H (g)	L (mm)	ΦT <sub>2</sub> (g)
NS187A-1002	230	280	403
NS187A-1004	340	280	502
NS187A-1006	450	310	680
NS187A-1008	680	340	950
NS187A-1010	910	350	1205
NS187A-1012	1130	400	1470



**NS188** Hammer, Cutoff



Item No.	H (g)	L (mm)	ΔT <sub>20</sub> (g)
NS188-1002	300	280	420
NS188-1004	450	310	650
NS188-1006	600	340	900

**NS189B** Hammer, Engineer's Cross Pein



Item No.	H (g)	L (mm)	ΔT <sub>20</sub> (g)
NS189B-1002	500	310	650
NS189B-1004	900	350	1100

**NS191** Hammer, Sledge



Item No.	H (g)	L (mm)	ΔT <sub>20</sub> (g)
NS191-1002	450	310	610
NS191-1004	1000	400	1300
NS191-1006	1400	400	1700
NS191-1008	1500	400	1800
NS191-1010	1800	400	2100
NS191-1012	2000	400	2300
NS191-1014	2200	400	2500
NS191-1016	2500	700	3210
NS191-1018	2700	700	3410
NS191-1020	3000	700	3710
NS191-1022	3600	700	4310
NS191-1024	4000	900	4910
NS191-1026	4500	900	5410
NS191-1028	5000	900	5910
NS191-1030	5400	900	6310
NS191-1032	6400	900	7310
NS191-1034	7200	900	8110
NS191-1036	8000	900	8910
NS191-1038	8200	900	9110
NS191-1040	9100	900	10010
NS191-1042	9900	900	10810

**NS191G** Sledge Hammer



Item No.	H (g)	L (mm)	ΔT <sub>20</sub> (g)
NS191G-1002	450	310	640
NS191G-1004	1000	320	1200
NS191G-1006	1400	360	1620
NS191G-1008	1500	360	1720
NS191G-1010	1800	380	2020
NS191G-1012	2000	380	2240
NS191G-1014	2200	400	2440
NS191G-1016	2500	400	2740
NS191G-1018	2700	400	2940
NS191G-1020	3000	700	3630
NS191G-1022	3600	700	4230
NS191G-1024	4000	800	4790
NS191G-1026	4500	800	5290
NS191G-1028	5000	800	5790
NS191G-1030	5400	800	6190
NS191G-1032	6400	800	7190
NS191G-1034	7200	900	8130
NS191G-1036	8000	900	8930
NS191G-1038	8200	900	9130
NS191G-1040	9100	900	10030
NS191G-1042	9900	900	10830

**NS189** Hammer, Pein



Item No.	H (g)	L (mm)	ΔT <sub>20</sub> (g)
NS189-1002	250	330	461
NS189-1004	300	330	570

**NS190** Hammer, Scaling



Item No.	H (g)	L (mm)	ΔT <sub>20</sub> (g)
NS190-1002	150	280	205
NS190-1004	300	280	370

**NS191A** Hammer, Sledge



Item No.	Size (g)	L (mm)	ΔT <sub>20</sub> (g)
NS191A-1002	450	310	450
NS191A-1004	1000	400	1000
NS191A-1006	1400	400	1400
NS191A-1008	1500	400	1500
NS191A-1010	1800	400	1800
NS191A-1012	2000	400	2000
NS191A-1014	2200	400	2200
NS191A-1016	2500	700	2500
NS191A-1018	2700	700	2700
NS191A-1020	3000	700	3000
NS191A-1022	3600	700	3600
NS191A-1024	4000	900	4000
NS191A-1026	4500	900	4500
NS191A-1028	5000	900	5000
NS191A-1030	5400	900	5400
NS191A-1032	6400	900	6400
NS191A-1034	7200	900	7200
NS191A-1036	8000	900	8000
NS191A-1038	8200	900	8200
NS191A-1040	9100	900	9100
NS191A-1042	9900	900	9900

**NS191H** Sledge Hammer



Item No.	Size (g)	L (mm)	ΔT <sub>20</sub> (g)
NS191H-1002	450	310	450
NS191H-1004	1000	360	1000
NS191H-1006	1400	360	1400
NS191H-1008	1500	360	1500
NS191H-1010	1800	380	1800
NS191H-1012	2000	380	2000
NS191H-1014	2200	400	2200
NS191H-1016	2500	400	2500
NS191H-1018	2700	400	2700
NS191H-1020	3000	700	3000
NS191H-1022	3600	700	3600
NS191H-1024	4000	800	4000
NS191H-1026	4500	800	4500
NS191H-1028	5000	800	5000
NS191H-1030	5400	800	5400
NS191H-1032	6400	800	6400
NS191H-1034	7200	900	7200
NS191H-1036	8000	900	8000
NS191H-1038	8200	900	8200
NS191H-1040	9100	900	9100
NS191H-1042	9900	900	9900

**NS189A** Hammer, Cutoff (Japan Type)

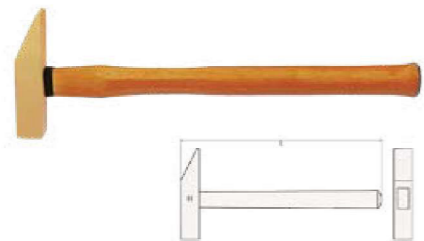

Item No.	H (g)	L (mm)	ΔT <sub>20</sub> (g)
NS189A-1002	230	280	420
NS189A-1004	380	450	500

**NS191C** Hammer, Sledge (German Type)



Item No.	H (g)	L (mm)	ΔT <sub>20</sub> (g)
NS191C-1002	500	310	650
NS191C-1004	1000	400	1300
NS191C-1006	1500	400	1800
NS191C-1008	2000	400	2300
NS191C-1010	3000	700	3700
NS191C-1012	4000	900	4900
NS191C-1014	5000	900	5900

**NS191D** Club Hammer



Item No.	Size lt	Φ <sub>TD</sub> (g)
NS191D-1002	2	910
NS191D-1004	4	1800

**NS192** Hammer, Testing



Item No.	H (g)	L (mm)	Φ <sub>TD</sub> (g)
NS192-1002	150	300	206
NS192-1004	250	335	345

**NS192B** Hammer, Sledge (German Type)



Item No.	H (g)	L (mm)	Φ <sub>TD</sub> (g)
NS192B-1004	1000	370	1300
NS192B-1006	1500	370	1800
NS192B-1008	2000	370	2300
NS192B-1010	3000	900	3950
NS192B-1012	4000	900	4950
NS192B-1014	5000	900	5950

**NS194A** Pick Railroad



Item No.	Size	L (mm)	Beryllium Copper (g)	Aluminium Bronze (g)
NS194A-1002	1#	910	2100	2000
NS194A-1004	2#	910	2950	2800
NS194A-1006	3#	910	3385	3200
NS194A-1008	4#	910	4330	4000

**NS191E** Nylon Hammer



Item No.	Size (g)	L (mm)	Φ <sub>TD</sub> (g)
NS191E-1002	800	340	800
NS191E-1004	1000	400	1000

**NS192A** Sledge Hammer



Item No.	H (g)	L (mm)	Φ <sub>TD</sub> (g)
NS192A-1002	1000	370	1300
NS192A-1004	1400	370	1700
NS192A-1006	1500	370	1800
NS192A-1008	1800	370	2100
NS192A-1010	2000	370	2300
NS192A-1012	2200	370	2500
NS192A-1014	2500	900	3460
NS192A-1016	2700	900	3660
NS192A-1018	3000	900	3960
NS192A-1020	3600	900	4560
NS192A-1022	4000	900	4960
NS192A-1024	4500	900	5460
NS192A-1026	5000	900	5960
NS192A-1028	5400	900	6360
NS192A-1030	6400	900	7360
NS192A-1032	7200	900	8160
NS192A-1034	8000	900	8960
NS192A-1036	8200	900	9160
NS192A-1038	9100	900	10060
NS192A-1040	9900	900	10860

**NS193** Hammer, Plumb

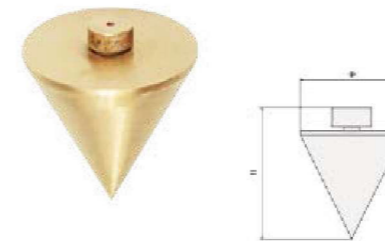

Item No.	H (mm)	Φ (mm)	Beryllium Copper (g)	Aluminium Bronze (g)
NS193-1002	59	50	275	247

**NS195** Axe Fireman



Item No.	L (mm)	H (mm)	B (mm)	Beryllium Copper (g)	Aluminium Bronze (g)
NS195-1002	340	200	98	1425	1300

**NS191F** Nylon Hammer



Item No.	Size (g)	L (mm)	Φ <sub>TD</sub> (g)
NS191F-1002	420	280	420
NS191F-1004	650	340	650

**NS194** Pick Railroad



Item No.	Size	A (mm)	L (mm)	Beryllium Copper (g)	Aluminium Bronze (g)
NS194-1002	1#	360	910	2100	2000
NS194-1004	2#	385	910	2950	2800
NS194-1006	3#	410	910	3385	3200
NS194-1008	4#	470	910	3715	3500

**NS196** Axe



Item No.	L (mm)	H (mm)	B (mm)	Beryllium Copper (g)	Aluminium Bronze (g)
NS196-1002	340	145	82	980	890

NS197 Anvil Block

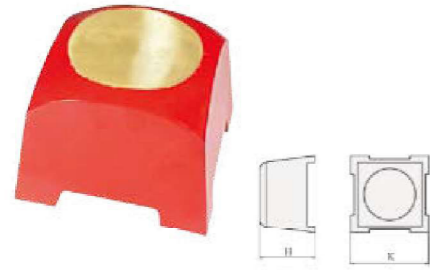

Item No.	Size (g)	H (mm)	K (mm)
NS197-1002	3000	63	92
NS197-1004	5000	75	111
NS197-1006	16000	114	160

NS199 Dust Pan

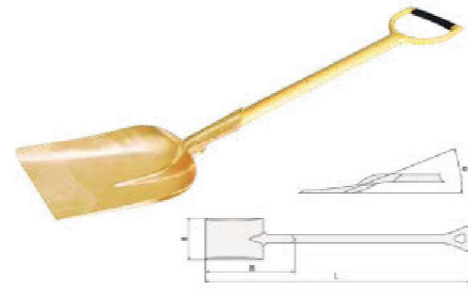

Item No.	L (mm)	B (mm)	H (mm)	Beryllium Copper (g)	Aluminium Bronze (g)
NS199-1002	990	270	520	2330	2130

NS198 Shovel, Square

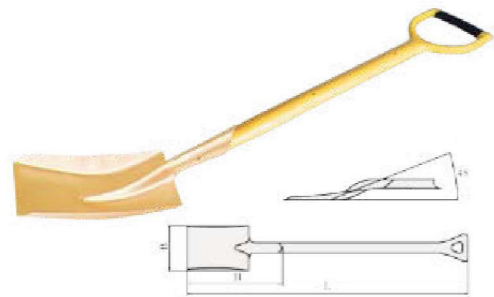

Item No.	L (mm)	B (mm)	H (mm)	Beryllium Copper (g)	Aluminium Bronze (g)
NS198-1002	940	175	340	1410	1290
NS198-1004	990	240	418	1804	1650

NS200 Shovel, Round Point

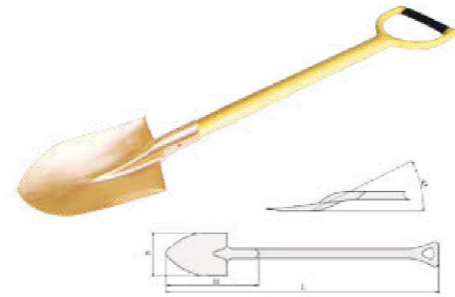

Item No.	L (mm)	B (mm)	H (mm)	Beryllium Copper (g)	Aluminium Bronze (g)
NS200-1002	990	240	420	1553	1420

NS198A Shovel, Square

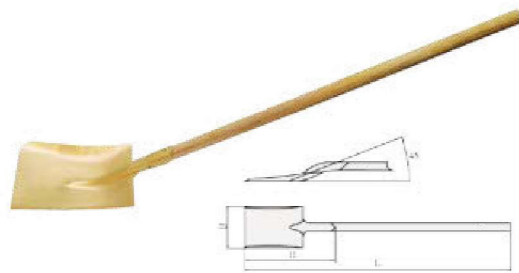

Item No.	L (mm)	B (mm)	H (mm)	Beryllium Copper (g)	Aluminium Bronze (g)
NS198A-1002	1400	175	340	1800	1680
NS198A-1004	1450	240	418	2200	2050

NS200A Shovel, Round Point

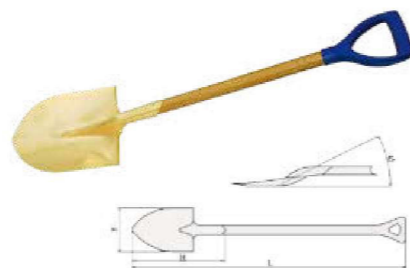

Item No.	L (mm)	B (mm)	H (mm)	Beryllium Copper (g)	Aluminium Bronze (g)
NS200A-1002	830	170	300	1300	1220

NS200B Shovel, Round Point

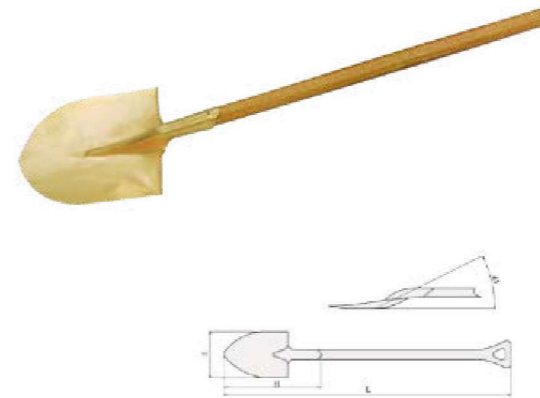

Item No.	L (mm)	B (mm)	H (mm)	Beryllium Copper (g)	Aluminium Bronze (g)
NS200B-1002	1450	240	420	1553	1420

NS201 Folding Spade

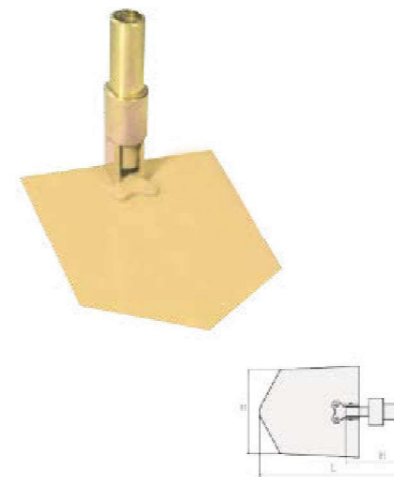

Item No.	L (mm)	B (mm)	H (mm)	Beryllium Copper (g)	Aluminium Bronze (g)
NS201-1002	320	180	130	1500	1350

NS201A Edging Spade

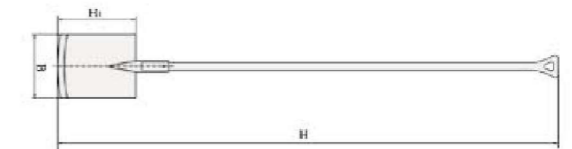

Item No.	H (mm)	B (mm)	H1 (mm)	Beryllium Copper (g)	Aluminium Bronze (g)
NS201A-1002	1390	195	290	3500	3200
NS201A-1004	1440	175	340	3700	3480



**NS202** Knife, Common

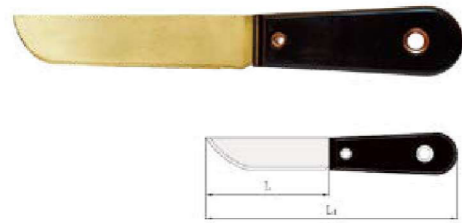

Item No.	L (mm)	L <sub>1</sub> (mm)	Beryllium Copper (g)	Aluminium Bronze (g)
NS202-1002	80	185	75	105
NS202-1004	145	250	95	125

**NS203** Knife, Putty



Item No.	K (mm)	L (mm)	L <sub>1</sub> (mm)	Beryllium Copper (g)	Aluminium Bronze (g)
NS203-1002	25	95	200	75	90
NS203-1004	40	95	200	95	115
NS203-1006	50	95	200	105	120
NS203-1008	65	95	200	115	125

**NS204** Knife, Putty



Item No.	K (mm)	L (mm)	L <sub>1</sub> (mm)	Beryllium Copper (g)	Aluminium Bronze (g)
NS204-1002	75	95	200	100	165
NS204-1004	100	95	200	105	195
NS204-1006	150	145	250	215	310

**NS204A** Spatula

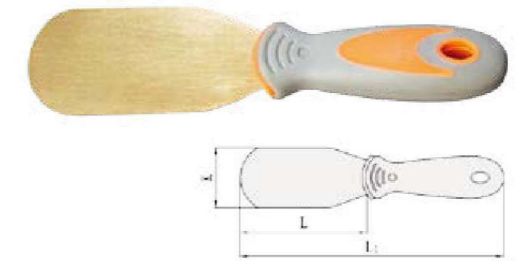

Item No.	B (mm)	L (mm)	L <sub>1</sub> (mm)	Beryllium Copper (g)	Aluminium Bronze (g)
NS204A-1002	30	203	90	85	80
NS204A-1004	50	218	105	115	110
NS204A-1006	90	233	120	160	145

**NS202A** Knife



Item No.	L (mm)	L <sub>1</sub> (mm)	Beryllium Copper (g)	Aluminium Bronze (g)
NS202A-1002	90	203	80	110

**NS203A** Knife, Putty

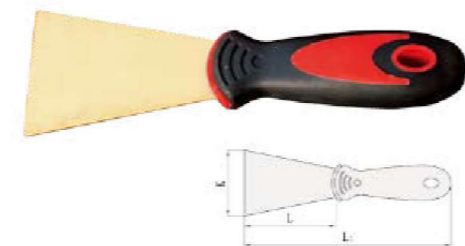

Item No.	K (mm)	L (mm)	L <sub>1</sub> (mm)	Beryllium Copper (g)	Aluminium Bronze (g)
NS203A-1002	25	90	203	75	90
NS203A-1004	40	90	203	95	115
NS203A-1006	50	90	200	105	120
NS203A-1008	65	90	203	115	125

**NS204C** Knife, Putty

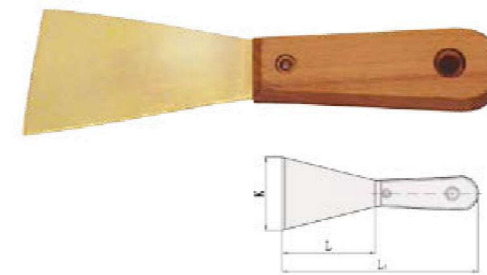

Item No.	K (mm)	L (mm)	L <sub>1</sub> (mm)	Beryllium Copper (g)	Aluminium Bronze (g)
NS204C-1002	25	95	200	75	90
NS204C-1004	40	95	200	95	115
NS204C-1006	50	95	200	105	120
NS204C-1008	65	95	200	115	125

**NS204B** Electrician Knife

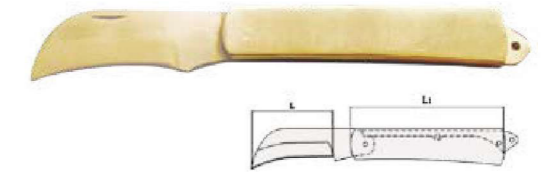

Item No.	L (mm)	L <sub>1</sub> (mm)	Beryllium Copper (g)	Aluminium Bronze (g)
NS204B-1002	61	113	210	185

**NS202B** Knife, Common



Item No.	L (mm)	L <sub>1</sub> (mm)	Beryllium Copper (g)	Aluminium Bronze (g)
NS202B-1002	80	193	75	105
NS202B-1004	137	250	95	125

**NS203B** Knife, Putty

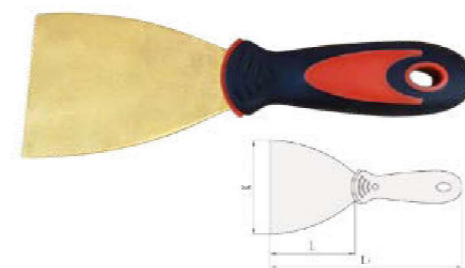

Item No.	K (mm)	L (mm)	L <sub>1</sub> (mm)	Beryllium Copper (g)	Aluminium Bronze (g)
NS203B-1002	75	90	203	150	165
NS203B-1004	100	90	203	175	195
NS203B-1006	150	140	253	280	310

**NS204E** Knife, Putty



Item No.	K (mm)	L (mm)	L <sub>1</sub> (mm)	Beryllium Copper (g)	Aluminium Bronze (g)
NS204E-1002	75	95	200	100	165
NS204E-1004	100	95	200	105	195
NS204E-1006	150	145	250	215	310

**NS204D** Spatula

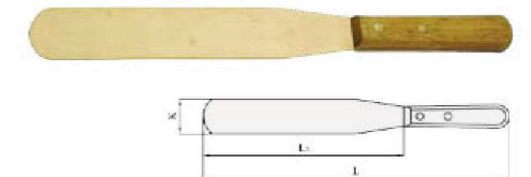

Item No.	K (mm)	L (mm)	L <sub>1</sub> (mm)	Beryllium Copper (g)	Aluminium Bronze (g)
NS204D-1002	40	350	230	120	110

NS204F Knife



Item No.	L (mm)	L <sub>1</sub> (mm)	Beryllium Copper (g)	Aluminium Bronze (g)
NS204F-1002	110	216	90	120

NS204G Knife

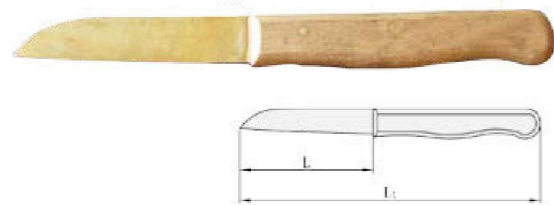

Item No.	L (mm)	L <sub>1</sub> (mm)	Beryllium Copper (g)	Aluminium Bronze (g)
NS204G-1002	75	180	90	120

NS205 Scraper

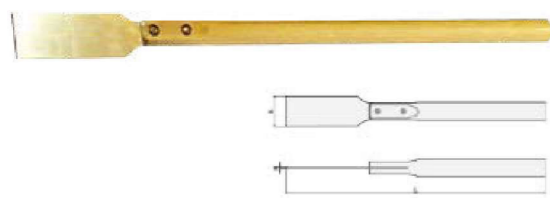

Item No.	L (mm)	B (mm)	H (mm)	Beryllium Copper (g)	Aluminium Bronze (g)
NS205-1002	902	50	2	683	625

NS205A Scraper

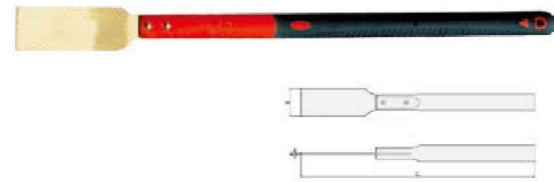

Item No.	L (mm)	B (mm)	H (mm)	Beryllium Copper (g)	Aluminium Bronze (g)
NS205A-1002	902	50	2	683	625

NS206 Scraper, Flat

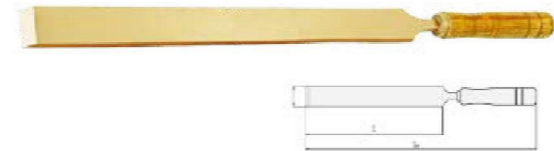

Item No.	L (mm)	B (mm)	L <sub>1</sub> (mm)	Beryllium Copper (g)	Aluminium Bronze (g)
NS206-1002	200	30	325	330	300
NS206-1004	300	30	430	480	440
NS206-1006	350	35	490	640	580
NS206-1008	350	50	500	1020	910
NS206-1010	400	60	560	1520	1330

NS207 Scraper, Deck



Item No.	L (mm)	B (mm)	Beryllium Copper (g)	Aluminium Bronze (g)
NS207-1002	250	39	285	255
NS207-1004	300	45	380	335
NS207-1006	350	55	555	507
NS207-1008	400	50	775	700
NS207-1010	650	56	1405	1290
NS207-1012	750	58	1540	1380

Item No.	L (inch)	B (inch)	Beryllium Copper (g)	Aluminium Bronze (g)
NS207A-1002	12	2	460	425

NS208 Scraper, Deck



Item No.	L (mm)	B (mm)	Beryllium Copper (g)	Aluminium Bronze (g)
NS208-1002	270	40	371	338

NS209 Scraper, Deck

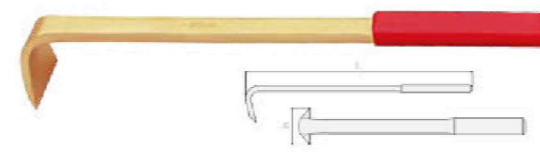

Item No.	L (mm)	B (mm)	Beryllium Copper (g)	Aluminium Bronze (g)
NS209-1002	300	48	432	391

NS210 Scraper, Deck

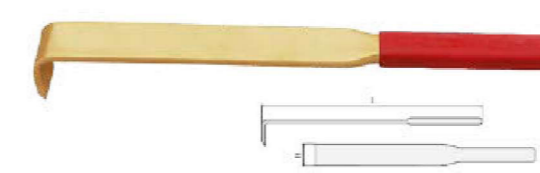

Item No.	L (mm)	B (mm)	Beryllium Copper (g)	Aluminium Bronze (g)
NS210-1002	380	38	821	720

NS211 Scraper, Spray Booth

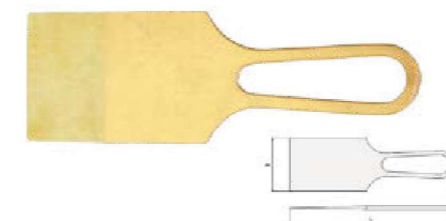

Item No.	L (mm)	B (mm)	Beryllium Copper (g)	Aluminium Bronze (g)
NS211-1002	235	76	392	358

NS212 Scraper



Item No.	L (mm)	L <sub>1</sub> (mm)	B (mm)	Beryllium Copper (g)	Aluminium Bronze (g)
NS212-1002	690	90	50	550	520
NS212-1004	705	100	75	750	700
NS212-1006	720	115	100	850	800
NS212-1008	765	150	150	1400	1300

NS212A Scraper, Hand Style

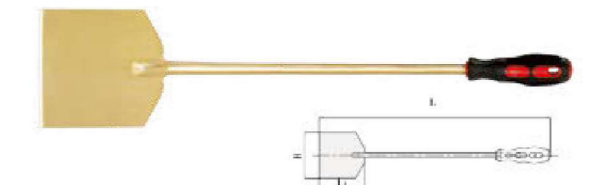

Item No.	L (mm)	L <sub>1</sub> (mm)	B (mm)	Beryllium Copper (g)	Aluminium Bronze (g)
NS212A-1002	480	95	95	600	540

NS212B Scraper, Rust

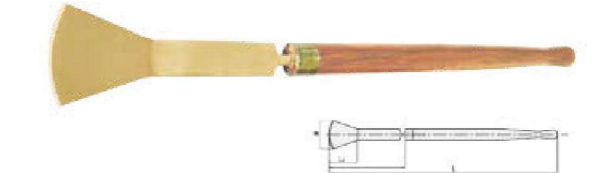

Item No.	L (mm)	B (mm)	L <sub>1</sub> (mm)	Beryllium Copper (g)	Aluminium Bronze (g)
NS212B-1002	600	75	75	700	620

NS213 Scraper, Arched

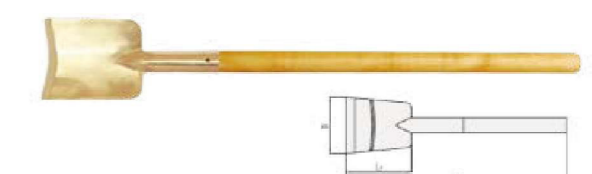

Item No.	L (mm)	L <sub>1</sub> (mm)	L <sub>2</sub> (mm)	Beryllium Copper (g)	Aluminium Bronze (g)
NS213-1002	600	120	50	650	600
NS213-1004	710	120	100	925	830
NS213-1006	720	120	150	1080	980

**NS213A** Scraper, Floor

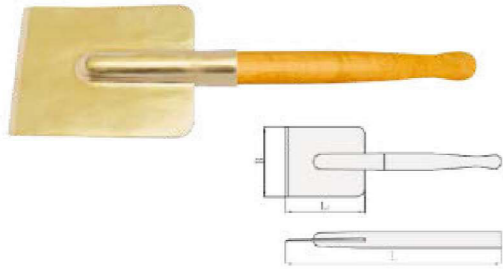

Item No.	L (mm)	L <sub>1</sub> (mm)	B (mm)	Beryllium Copper (g)	Aluminium Bronze (g)
NS213A-1002	460	170	150	1150	1000

**NS215A** Trowel Bricklayer's

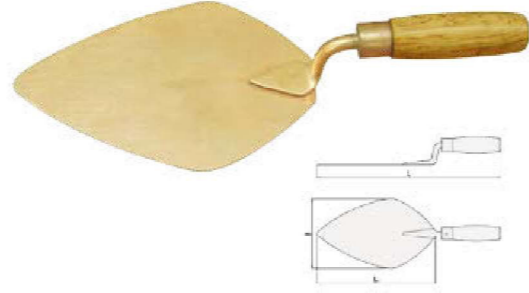

Item No.	L (mm)	L <sub>1</sub> (mm)	B (mm)	Beryllium Copper (g)	Aluminium Bronze (g)
NS215A-1002	335	215	130	700	620

**NS217** File, Flat

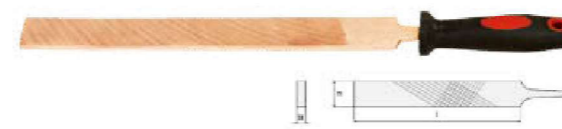

Item No.	L (inch)	L (mm)	B (mm)	H (mm)	Beryllium Copper (g)
NS217-1002	6	150	16	4	75
NS217-1004	8	200	21	4,5	160
NS217-1006	10	250	25	6	282
NS217-1008	12	300	30	6,5	455
NS217-1010	14	350	32	8	675
NS217-1012	16	400	32	9,5	925

**NS220** File, Square

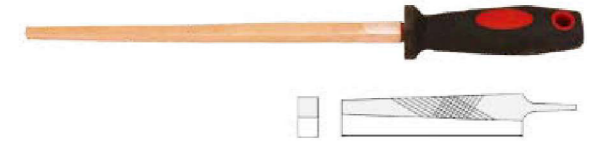

Item No.	L (inch)	L (mm)	B (mm)	Beryllium Copper (g)
NS220-1002	8	200	8	130
NS220-1004	10	250	10	155
NS220-1006	12	300	11	202
NS220-1008	14	350	12	303

**NS214** Opener Carbide Drum

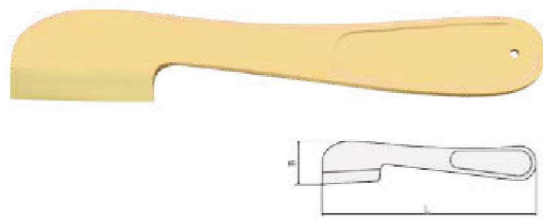

Item No.	L (mm)	B (mm)	Beryllium Copper (g)	Aluminium Bronze (g)
NS214-1002	280	53	655	595

**NS215B** Trapezia Shovel Bricklayer's

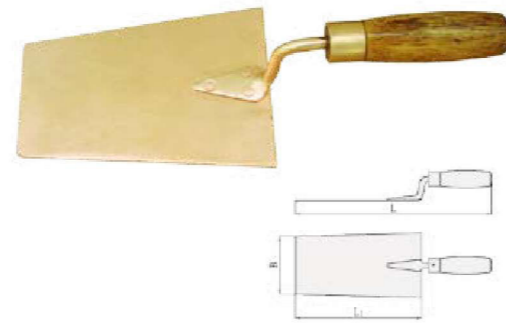

Item No.	L (mm)	L <sub>1</sub> (mm)	B (mm)	Beryllium Copper (g)	Aluminium Bronze (g)
NS215B-1002	290	160	80	420	390

**NS218** File, Half Round

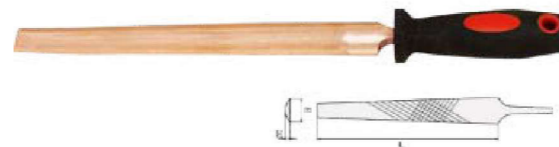

Item No.	L (inch)	L (mm)	B (mm)	H (mm)	Beryllium Copper (g)
NS218-1002	6	150	22	6	105
NS218-1004	8	200	23	7	190
NS218-1006	10	250	26	8	255
NS218-1008	12	300	28	9	375
NS218-1010	14	350	30	10	565

**NS221** File, Triangle

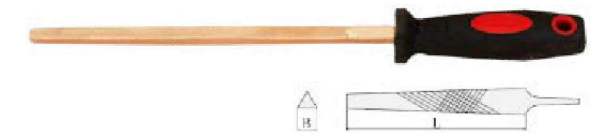

Item No.	L (inch)	L (mm)	B (mm)	Beryllium Copper (g)
NS221-1002	8	200	12	115
NS221-1004	10	250	13	125
NS221-1006	12	300	14	160
NS221-1008	14	350	14	205

**NS215** Scraper, Tile Cleaver

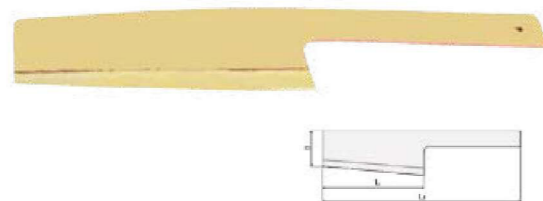

Item No.	L (mm)	L <sub>1</sub> (mm)	B (mm)	Beryllium Copper (g)	Aluminium Bronze (g)
NS215-1002	180	350	55	610	550

**NS216** Plane's Blade

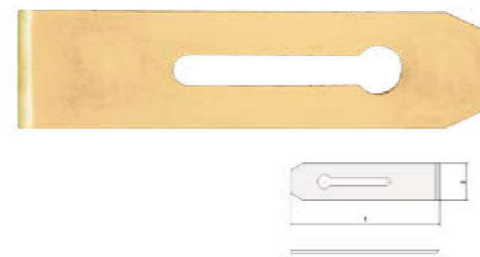

Item No.	L (mm)	B (mm)	Beryllium Copper (g)
NS216-1002	175	43	130

**NS219** File, Round



Item No.	L (inch)	L (mm)	Φ (mm)	Beryllium Copper (g)
NS219-1002	6	150	6,5	45
NS219-1004	8	200	7,5	91
NS219-1006	10	250	8,5	122
NS219-1008	12	300	9,5	180
NS219-1010	14	350	10,5	250

**NS222** Punch, Machinists

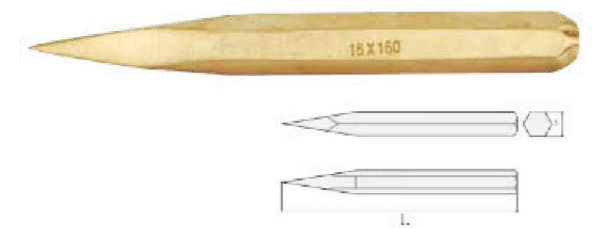

Item No.	S (mm)	L (mm)	Beryllium Copper (g)	Aluminium Bronze (g)
NS222-1002	14	150	165	155
NS222-1004	18	200	385	355
NS222-1006	20	250	610	555
NS222-1008	20	300	725	660



**NS223A** Punch Machinists'



Item No.	Φ (mm)	L (mm)	Beryllium Copper (g)	Aluminium Bronze (g)
NS223A-1002	5	150	235	215
NS223A-1004	8	150	285	255
NS223A-1006	10	150	345	315

**NS223C** Punch



Item No.	Φ (mm)	Φ <sub>1</sub> (mm)	L (mm)	Beryllium Copper (g)	Aluminium Bronze (g)
NS223C-1002	5	11	150	105	95
NS223C-1004	6	12	150	130	115
NS223C-1006	7	13	150	150	135
NS223C-1008	8	14	150	170	150
NS223C-1010	10	16	175	255	230
NS223C-1012	12	18	175	335	300
NS223C-1014	13	29	255	1180	1060

**NS223D** Punch, Machinists'



Item No.	L (mm)	Φ (mm)	Beryllium Copper (g)	Aluminium Bronze (g)
NS223D-1002	160	18	290	265
NS223D-1004	250	18	470	425
NS223D-1006	300	18	600	545
NS223D-1008	300	20	700	635
NS223D-1010	300	25	1100	995
NS223D-1012	400	18	800	725
NS223D-1014	400	20	1000	885

**NS223B** Drift Cylindrical

DIN6450

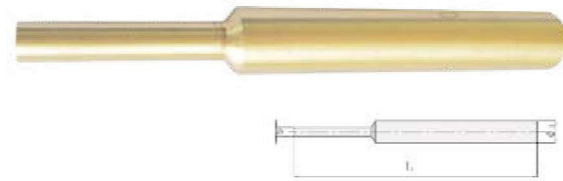

Item No.	Φ (mm)	Φ <sub>1</sub> (mm)	L (mm)	Beryllium Copper (g)	Aluminium Bronze (g)
NS223B-1002	3	9	110	20	15
NS223B-1004	4	10	110	57	50
NS223B-1006	6	12	115	105	95
NS223B-1008	8	14	120	130	115
NS223B-1010	10	16	145	200	180
NS223B-1012	12	18	160	280	260
NS223B-1014	14	20	180	410	380
NS223B-1016	16	24	200	640	600
NS223B-1018	18	30	225	1070	960
NS223B-1020	20	32	225	1230	1110

**NS223E** Drift pin, barrel straight

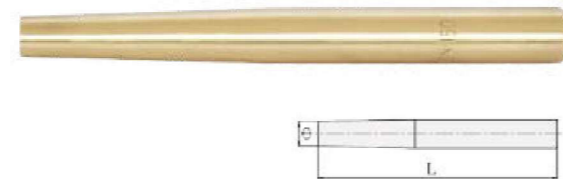

Item No.	Φ (mm)	Φ <sub>1</sub> (mm)	L (mm)	Beryllium Copper (g)	Aluminium Bronze (g)
NS223E-1002	8	11	150	125	118
NS223E-1004	10	13	150	155	140
NS223E-1006	12	15	150	215	190
NS223E-1008	14	18	200	420	380
NS223E-1010	15	19	200	435	390
NS223E-1012	16	20	200	480	435
NS223E-1014	17	21	200	570	540
NS223E-1016	18	22	250	600	560
NS223E-1018	19	23	250	860	780
NS223E-1020	20	24	250	875	790
NS223E-1022	21	25	250	950	885
NS223E-1024	22	26	250	965	920
NS223E-1026	24	28	250	1270	1150
NS223E-1028	25	29	250	1300	1170
NS223E-1030	26	30	250	1390	1250
NS223E-1032	27	31	300	1900	1770

**NS223** Chisel, Pneumatic Bull Point

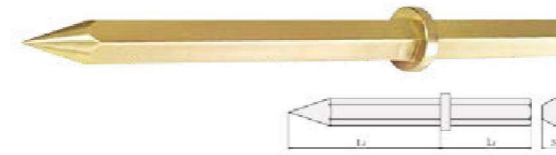

Item No.	S (mm)	L (mm)	L <sub>1</sub> (mm)	Beryllium Copper (g)	Aluminium Bronze (g)
NS223-1002	28	500	150	2650	2400

**NS224** Scraper, Triangular

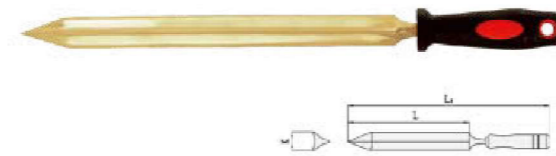

Item No.	L (mm)	L <sub>1</sub> (mm)	K (mm)	Beryllium Copper (g)	Aluminium Bronze (g)
NS224-1002	160	300	22	245	225
NS224-1004	300	400	26	645	590

**NS224A** Scraper Plate

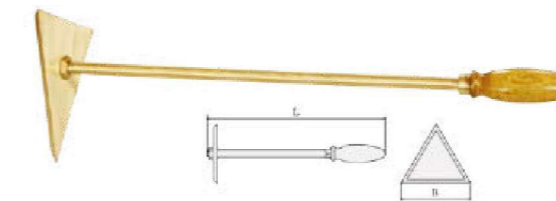

Item No.	L (mm)	B (mm)	Beryllium Copper (g)	Aluminium Bronze (g)
NS224A-1002	470	150	900	810

**NS224B** Scraper, Halfmoon



Item No.	L (mm)	B (mm)	Beryllium Copper (g)	Aluminium Bronze (g)
NS224B-1002	326	100	260	235

**NS224C** Scraper, Triangular

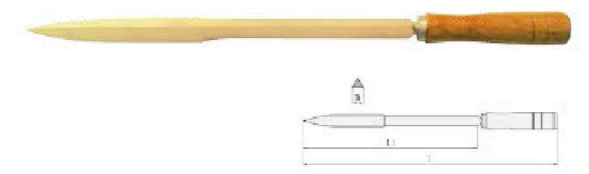

Item No.	L (mm)	L <sub>1</sub> (mm)	K (mm)	Beryllium Copper (g)	Aluminium Bronze (g)
NS224C-1002	440	300	20	420	380

**NS224D** Scraper, Half Round



Item No.	L (mm)	L <sub>1</sub> (mm)	B (mm)	H (mm)	Beryllium Copper (g)	Aluminium Bronze (g)
NS224D-1002	440	300	30	5	420	380

**NS225** Chisel, Cross

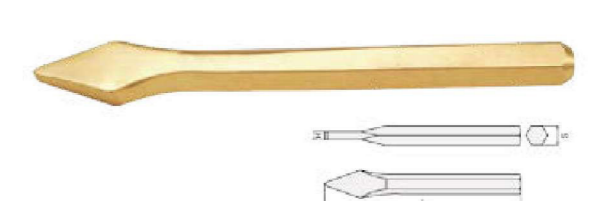

Item No.	S (mm)	L (mm)	H (mm)	Beryllium Copper (g)	Aluminium Bronze (g)
NS225-1002	20	200	8	475	432

**NS225A** Chisel, Cross Cutting

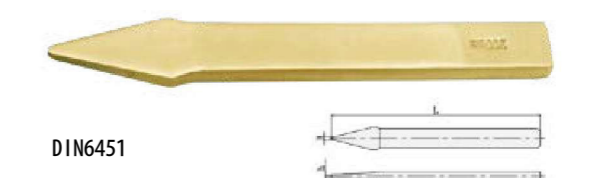

Item No.	L (mm)	B (mm)	H (mm)	Beryllium Copper (g)	Aluminium Bronze (g)
NS225A-1002	140	4	4	280	255
NS225A-1004	200	4	4	480	435
NS225A-1006	300	5	5	840	760

### NS225B Scraper Pick And Scaler

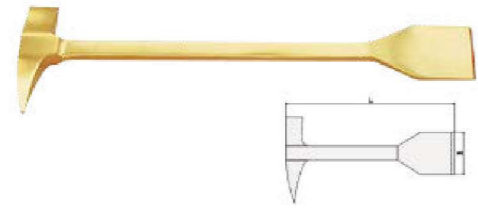

Item No.	L (mm)	B (mm)	Beryllium Copper (g)	Aluminium Bronze (g)
NS225B-1002	450	75	1285	1155

### NS225C Chisel, Flat



DIN6453

Item No.	B (mm)	L (mm)	Beryllium Copper (g)	Aluminium Bronze (g)
NS225C-1002	22	150	235	205
NS225C-1004	22	200	320	280
NS225C-1006	24	250	490	440
NS225C-1008	25	300	770	700
NS225C-1010	27	400	1220	1100

### NS226 Chisel, Pneumatic

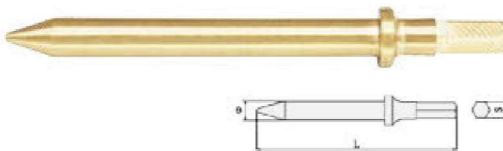

Item No.	S (mm)	L (mm)	Φ (mm)	Beryllium Copper (g)	Aluminium Bronze (g)
NS226-1002	10	125	12	117	102
NS226-1004	10	175	12	168	143

### NS227 Chisel, Pneumatic

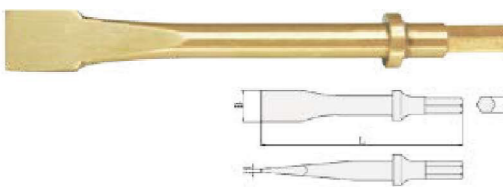

Item No.	S (mm)	L (mm)	B (mm)	H (mm)	Beryllium Copper (g)	Aluminium Bronze (g)
NS227-1002	10	125	20	2	160	141
NS227-1004	10	175	20	2	210	182

### NS228 Chisel, Pneumatic



Item No.	S (mm)	L (mm)	B (mm)	Beryllium Copper (g)	Aluminium Bronze (g)
NS228-1002	10	125	20	152	117
NS228-1004	10	175	20	190	122

### NS229 Chisel, Pneumatic

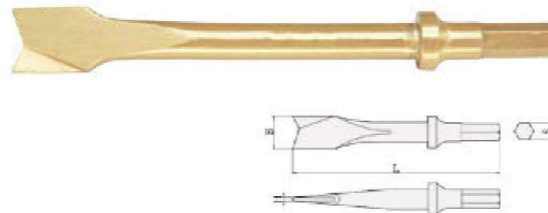

Item No.	S (mm)	L (mm)	H (mm)	B (mm)	Beryllium Copper (g)	Aluminium Bronze (g)
NS229-1002	10	125	2	20	162	142
NS229-1004	10	175	2	20	213	183

### NS230 Chisel, Pneumatic

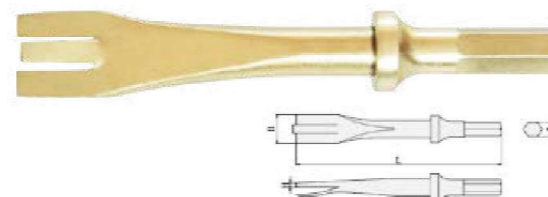

Item No.	S (mm)	L (mm)	B (mm)	H (mm)	Beryllium Copper (g)	Aluminium Bronze (g)
NS230-1002	10	125	20	2	127	112
NS230-1004	10	175	20	2	178	153

### NS231 Chisel, Flat

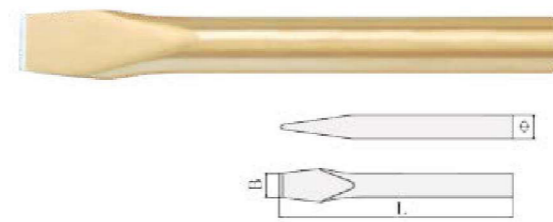

Item No.	L (mm)	Φ (mm)	B (mm)	Beryllium Copper (g)	Aluminium Bronze (g)
NS231-1002	160	14	14	175	160
NS231-1004	160	16	16	231	210
NS231-1006	160	18	18	295	271
NS231-1008	200	18	18	382	342
NS231-1010	200	20	20	473	430
NS231-1012	250	24	24	822	751
NS231-1014	300	24	24	1025	942
NS231-1016	300	25	25	1302	1002
NS231-1018	400	25	25	1502	1360
NS231-1020	500	25	25	1903	1730
NS231-1022	500	30	30	2730	2481

### NS232 Chisel Hex/6 Point

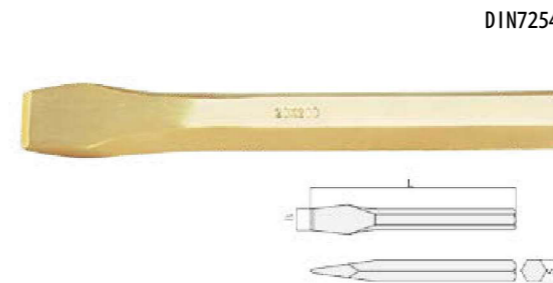

DIN7254

Item No.	S (mm)	L (mm)	B (mm)	Beryllium Copper (g)	Aluminium Bronze (g)
NS232-1002	10	150	12	98	92
NS232-1004	14	200	16	251	231
NS232-1006	16	160	18	262	242
NS232-1008	14	250	16	320	302
NS232-1010	17	300	19	772	701
NS232-1012	17	350	19	903	821
NS232-1014	22	600	24	1861	1702
NS232-1016	25	300	28	1204	1090
NS232-1018	30	500	35	2860	2620

### NS233A Chisel, Diamond Point

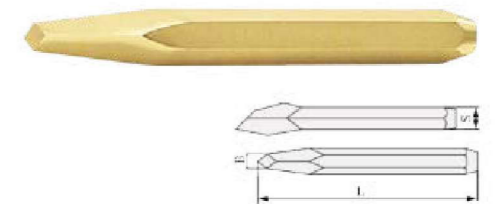

Item No.	S (mm)	L (mm)	B (mm)	Beryllium Copper (g)	Aluminium Bronze (g)
NS233A-1002	20	200	13	580	525

### NS234 Caulking Tool

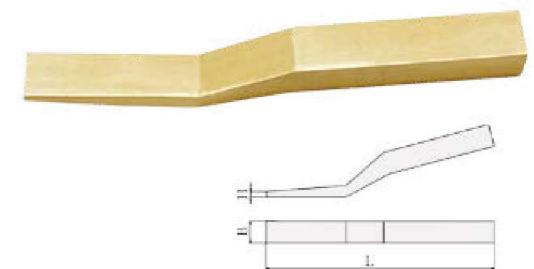

Item No.	L (mm)	B (mm)	H (mm)	Beryllium Copper (g)	Aluminium Bronze (g)
NS234-1002	200	20	5	495	455
NS234-1004	250	20	8	652	585

### NS234A Caulking Tool



Item No.	S (mm)	L (mm)	Beryllium Copper (g)	Aluminium Bronze (g)
NS234A-1002	50	1200	18450	16850

### NS235 Wedge, Flange

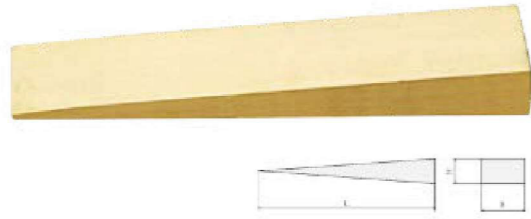

Item No.	L (mm)	B (mm)	H (mm)	Beryllium Copper (g)	Aluminium Bronze (g)
NS235-1002	80	13	6	25	23
NS235-1004	100	50	10	201	185
NS235-1006	135	50	18	497	455
NS235-1008	150	40	8	200	180
NS235-1010	150	25	8	122	112
NS235-1012	150	25	13	205	185
NS235-1014	150	50	13	400	365
NS235-1016	180	32	13	305	280
NS235-1018	180	50	19	700	640
NS235-1020	200	20	30	490	451
NS235-1022	200	30	30	740	675
NS235-1024	200	40	40	1315	1200
NS235-1026	200	50	12	500	450
NS235-1028	230	40	20	751	690
NS235-1030	250	40	30	1230	1125
NS235-1032	300	50	40	2460	2250

Item No.	L (inch)	B (inch)	H (inch)	Beryllium Copper (g)	Aluminium Bronze (g)
NS235-1001	4	3/4	1/2	110	100
NS235-1003	6	1	1/2	220	200
NS235-1005	6	1-1/2	3/4	480	435
NS235-1007	7	2	3/4	755	680
NS235-1009	8	1-1/2	1	855	770
NS235-1011	8-1/2	2	1-1/4	1500	1360

### NS236 Punch, Center

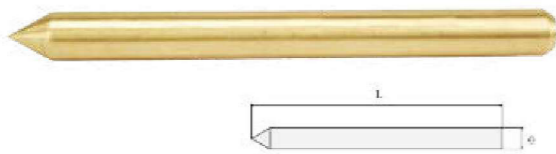

Item No.	L (mm)	Φ (mm)	Beryllium Copper (g)	Aluminium Bronze (g)
NS236-1002	100	16	145	125
NS236-1004	150	16	230	205
NS236-1006	200	18	392	340
NS236-1008	300	18	615	540
NS236-1010	400	18	820	740
NS236-1012	500	20	1230	1102
NS236-1014	500	30	2740	2480

### NS233 Chisel 8 Point

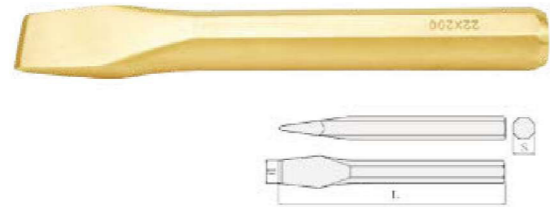

Item No.	L (mm)	S (mm)	B (mm)	Beryllium Copper (g)	Aluminium Bronze (g)
NS233-1002	160	14	14	186	170
NS233-1004	160	16	16	255	230
NS233-1006	180	19	19	402	366
NS233-1008	200	19	19	451	411
NS233-1010	200	22	22	650	562
NS233-1012	250	24	24	880	792
NS233-1014	300	24	24	1052	950
NS233-1016	300	30	30	1603	1450
NS233-1018	400	27	27	1780	1620

### NS237 Bar



Item No.	L (mm)	Φ (mm)	B (mm)	Beryllium Copper (g)	Aluminium Bronze (g)
NS237-1002	500	15	15	738	675
NS237-1004	500	19	19	1150	1050
NS237-1006	500	20	20	1295	1185
NS237-1008	500	25	25	1975	1805
NS237-1010	500	30	30	2925	2675
NS237-1012	600	25	25	2380	2175
NS237-1014	600	30	30	3450	3155
NS237-1016	800	23	23	2290	2095
NS237-1018	800	25	25	3175	2905
NS237-1020	800	30	30	4490	4105
NS237-1022	850	30	30	4870	4455
NS237-1024	1000	25	25	3985	3645
NS237-1026	1000	28	28	4710	4305
NS237-1028	1000	30	30	5595	5115
NS237-1030	1200	25	25	4795	4385
NS237-1032	1200	30	30	6970	6375
NS237-1034	1500	30	30	8665	7925

### NS237A Bar, Pinch

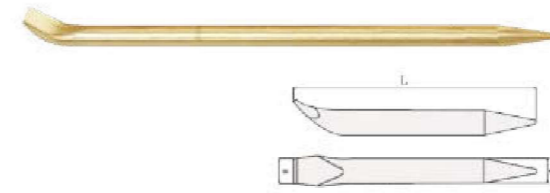

Item No.	L (mm)	Φ (mm)	B (mm)	Beryllium Copper (g)	Aluminium Bronze (g)
NS237A-1002	500	15	16	672	615
NS237A-1004	500	19	20	1093	1001
NS237A-1006	500	20	20	1148	1052
NS237A-1008	500	23	23	1481	1355
NS237A-1010	600	25	25	2132	1950
NS237A-1012	800	23	23	2530	2293
NS237A-1014	1000	30	28	5193	4752

### NS237B Bar (Hex) Pinch

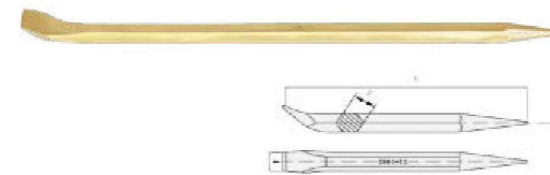

Item No.	L (mm)	S (mm)	B (mm)	Beryllium Copper (g)	Aluminium Bronze (g)
NS237B-1002	500	18	20	1200	1090
NS237B-1004	500	20	22	1450	1320
NS237B-1006	600	20	22	1750	1600
NS237B-1008	1000	22	24	3500	3200
NS237B-1010	1000	25	27	4500	4080
NS237B-1012	1500	25	27	6750	6120
NS237B-1014	1000	35	37	8800	8000

### NS237C Bar Crow



Item No.	L (mm)	H (mm)	B (mm)	Beryllium Copper (g)	Aluminium Bronze (g)
NS237C-1002	650	20	23	1855	1675
NS237C-1004	1500	30	25	8910	8110

Item No.	L (inch)	H (inch)	B (inch)	Beryllium Copper (g)	Aluminium Bronze (g)
NS237C-1001	60	1-1/4	1-3/8	8920	8050

### NS237D Bar, Pinch

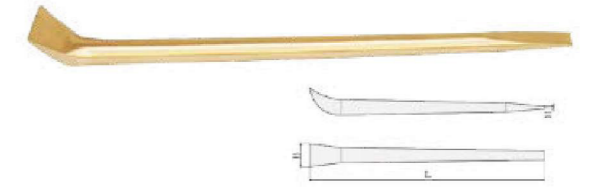

Item No.	L (mm)	H (mm)	B (mm)	Beryllium Copper (g)	Aluminium Bronze (g)
NS237D-1002	600	3	52	2435	2221

### NS237E Spike

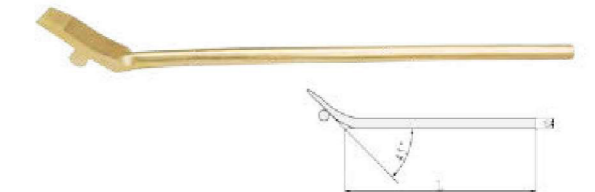

Item No.	L (mm)	B (mm)	Beryllium Copper (g)	Aluminium Bronze (g)
NS237E-1002	600	22	2320	2100

### NS238 Hearing Needle

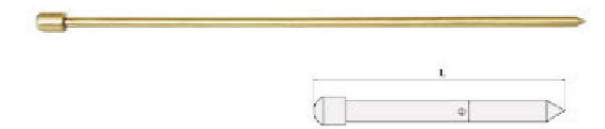

Item No.	L (mm)	Φ (mm)	Beryllium Copper (g)	Aluminium Bronze (g)
NS238-1002	250	6	85	75
NS238-1004	300	8	150	135
NS238-1006	400	7	160	145
NS238-1008	500	10	335	305



**NS238A** Hearing Needle With Ball

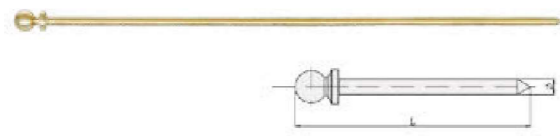

Item No.	L (mm)	Φ (mm)	Beryllium Copper (g)	Aluminium Bronze (g)
NS238A-1002	500	6	130	115

**NS240** Bar, Wrecking

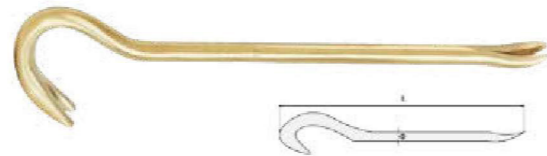

Item No.	L (mm)	Φ (mm)	Beryllium Copper (g)	Aluminium Bronze (g)
NS240-1002	400	16	752	685
NS240-1004	600	16	1102	1002
NS240-1006	800	19	2200	2011
NS240-1008	1200	20	3570	3266

**NS242** Shears, Cutting



Item No.	L (mm)	B (mm)	Beryllium Copper (g)	Aluminium Bronze (g)
NS242-1002	150	61	110	100

**NS244A** Scissors



Item No.	L (inch)	L (mm)	B (mm)	Beryllium Copper (g)	Aluminium Bronze (g)
NS244A-1002	9	225	98	245	210

**NS238B** Needle



Item No.	L (mm)	Φ (mm)	Beryllium Copper (g)
NS238B-1002	180	3	12

**NS240A** Bar, Wrecking Hex

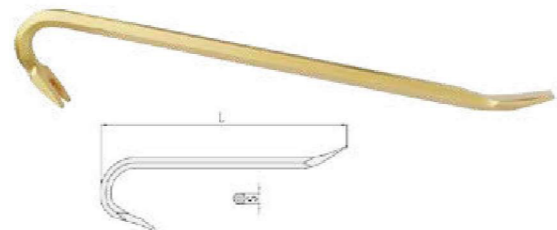

Item No.	L (mm)	S (mm)	Beryllium Copper (g)	Aluminium Bronze (g)
NS240A-1002	460	16	890	800
NS240A-1004	760	22	3100	2800
NS240A-1006	920	22	3650	3300

**NS243** Shears, Cutting

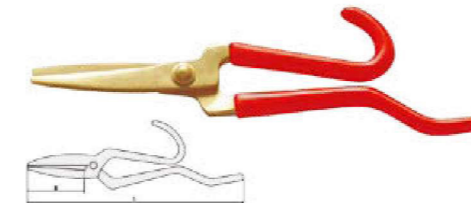

Item No.	L (mm)	B (mm)	Beryllium Copper (g)	Aluminium Bronze (g)
NS243-1002	290	91	235	215
NS243-1004	360	107	900	823

**NS244B** Tinner's Snip Plate Shear

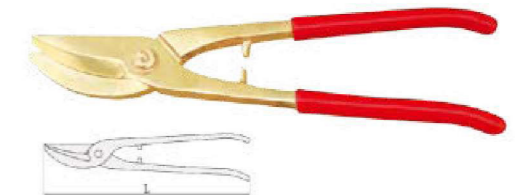

Item No.	L (mm)	Beryllium Copper (g)	Aluminium Bronze (g)
NS244B-1002	280	500	450

**NS239** Bar, Wrecking

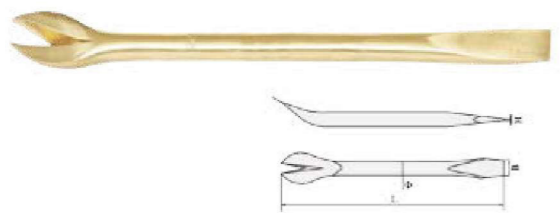

Item No.	L (mm)	Φ (mm)	B (mm)	H (mm)	Beryllium Copper (g)	Aluminium Bronze (g)
NS239-1002	250	13	15	1.5	280	250

**NS241** Crate Opener

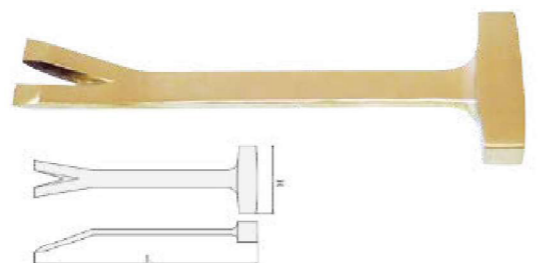

Item No.	L (mm)	H (mm)	Beryllium Copper (g)	Aluminium Bronze (g)
NS241-1002	230	70	471	430

**NS244** Shears, Tin



Item No.	L (mm)	B (mm)	Beryllium Copper (g)	Aluminium Bronze (g)
NS244-1002	300	75	488	410

**NS244C** Shears



Item No.	L (mm)	Beryllium Copper (g)	Aluminium Bronze (g)
NS244C-1002	200	488	410

**NS245** Pliers, Adjustable Combination

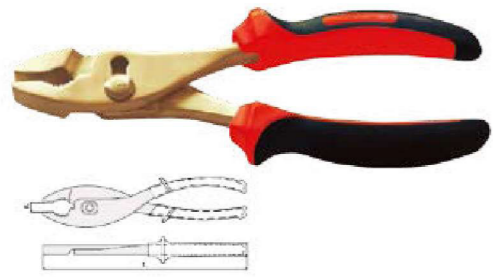

Item No.	L (inch)	L (mm)	K (mm)	Beryllium Copper (g)	Aluminium Bronze (g)
NS245-1002	6	150	8	213	195
NS245-1004	8	200	13	380	350

**NS247** Pliers, Cutting

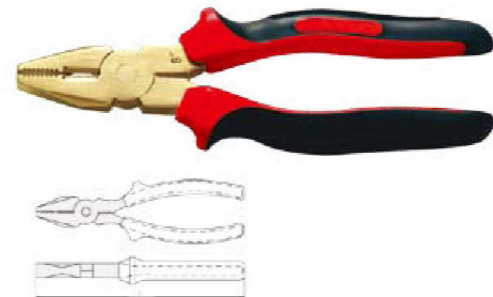

Item No.	L (inch)	L (mm)	Beryllium Copper (g)	Aluminium Bronze (g)
NS247-1002	8	200	470	420

**NS249A** Pincers

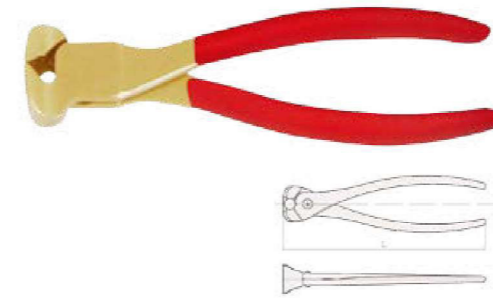

Item No.	L (inch)	L (mm)	Beryllium Copper (g)	Aluminium Bronze (g)
NS249A-1002	7	175	250	225

**NS252** Pliers, Slip Joint

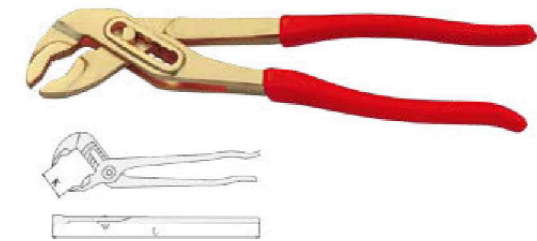

Item No.	L (inch)	L (mm)	K <sub>max</sub> (mm)	Beryllium Copper (g)	Aluminium Bronze (g)
NS252-1002	10	250	32	365	335

**NS245A** Gas Pliers

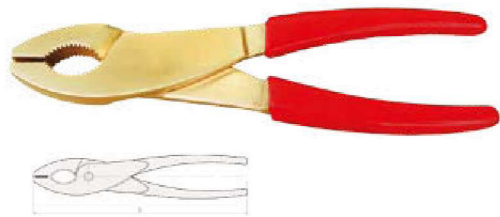

Item No.	L (mm)	Beryllium Copper (g)	Aluminium Bronze (g)
NS245A-1002	200	350	315

**NS248** Pliers, Diagonal Cutting



Item No.	L (inch)	L (mm)	Beryllium Copper (g)	Aluminium Bronze (g)
NS248-1002	6	150	245	225
NS248-1004	8	200	410	365

**NS250** Pliers, Flat Nose

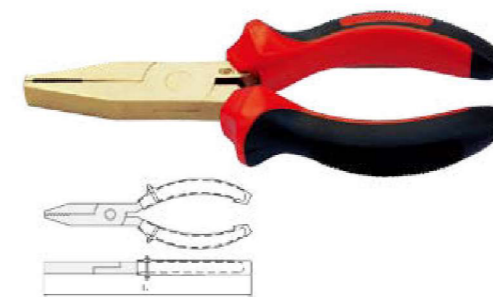

Item No.	L (inch)	L (mm)	Beryllium Copper (g)	Aluminium Bronze (g)
NS250-1002	6	150	165	151
NS250-1004	8	200	281	257

**NS252A** Pliers, Water Pump



Item No.	L (inch)	L (mm)	K <sub>max</sub> (mm)	Beryllium Copper (g)	Aluminium Bronze (g)
NS252A-1002	10	250	32	325	310
NS252A-1004	12	300	52	665	610

**NS246** Pliers, Lineman



Item No.	L (inch)	L (mm)	Beryllium Copper (g)	Aluminium Bronze (g)
NS246-1002	6	150	180	165
NS246-1004	7	175	355	330
NS246-1006	8	200	465	435
NS246-1008	10	250	550	500

**NS249** Pincers

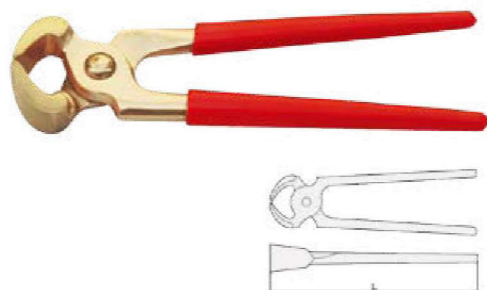

Item No.	L (inch)	L (mm)	Beryllium Copper (g)	Aluminium Bronze (g)
NS249-1002	8	200	325	300

**NS251** Pliers, Groove Joint

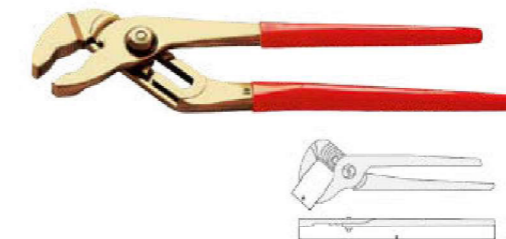

Item No.	L (inch)	L (mm)	K <sub>max</sub> (mm)	Beryllium Copper (g)	Aluminium Bronze (g)
NS251-1002	6	150	25	180	160
NS251-1004	10	175	45	425	370
NS251-1006	12	200	55	670	600
NS251-1008	14	250	55	850	770

**NS253** Pliers, Snipe Nose

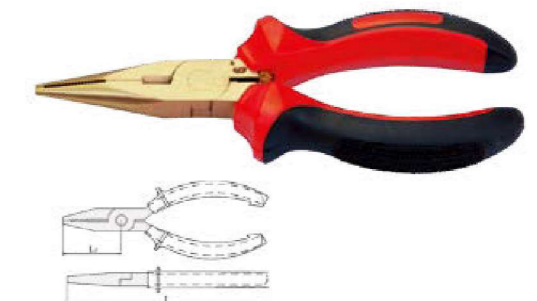

Item No.	L (inch)	L (mm)	L <sub>1</sub> (mm)	Beryllium Copper (g)	Aluminium Bronze (g)
NS253-1002	6	150	54	190	170
NS253-1004	8	200	74	335	300

**NS254** Pliers, Long Nose

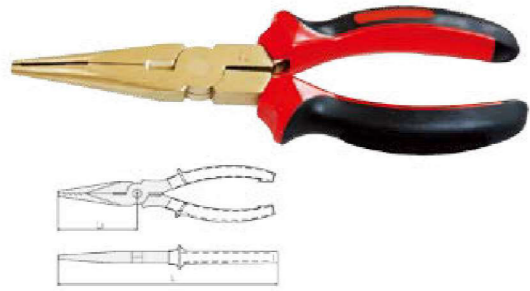

Item No.	L (inch)	L (mm)	L <sub>1</sub> (mm)	Beryllium Copper (g)	Aluminium Bronze (g)
NS254-1002	6	150	54	190	170
NS254-1004	8	200	74	335	300

**NS256** Pliers, Snap Ring-Internal

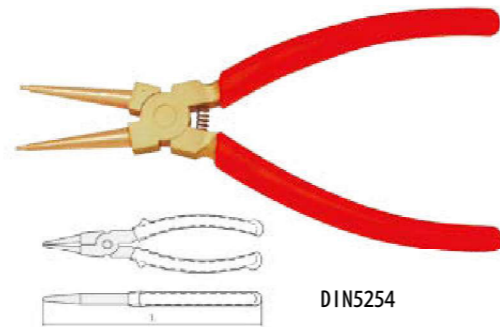

Item No.	L (inch)	L (mm)	Beryllium Copper (g)	Aluminium Bronze (g)
NS256-1002	8	200	290	265
NS256-1004	10	250	415	380

DIN5254

**NS255** Pliers, Round Nose

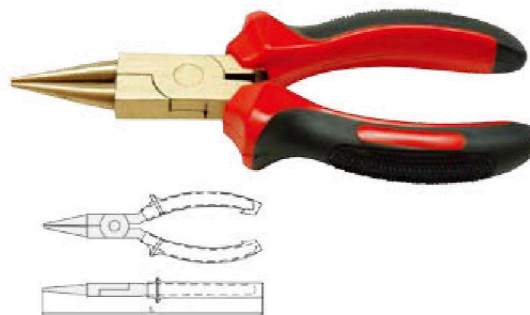

Item No.	L (inch)	L (mm)	Beryllium Copper (g)	Aluminium Bronze (g)
NS255-1002	6	150	165	150

**NS257** Pliers, Snap Ring-External

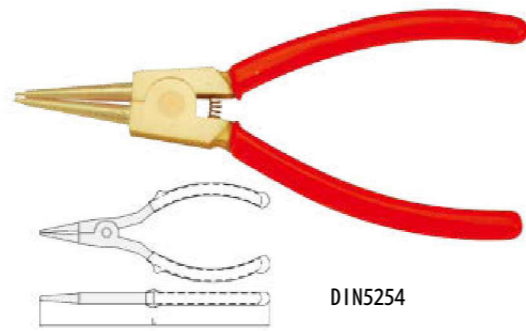

Item No.	L (inch)	L (mm)	Beryllium Copper (g)	Aluminium Bronze (g)
NS257-1002	8	200	290	265
NS257-1004	10	250	415	380

DIN5254

**NS255A** Pliers, Round 45 Degree Bent

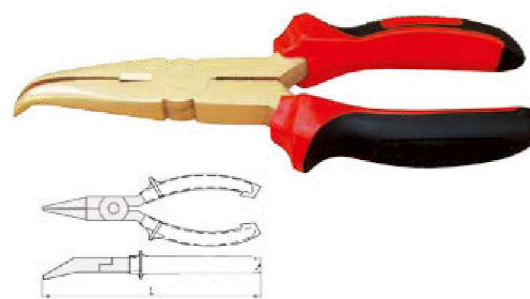

Item No.	L (inch)	L (mm)	Beryllium Copper (g)	Aluminium Bronze (g)
NS255A-1002	6	150	190	170

**NS257A** Bolt Chipper



Item No.	L (mm)	D (mm)	Beryllium Copper (g)	Aluminium Bronze (g)
NS257A-1002	600	6	3350	3070
NS257A-1004	900	8	9250	8400

**NS257B** Crimping Tool, Insulated Cable Connectors

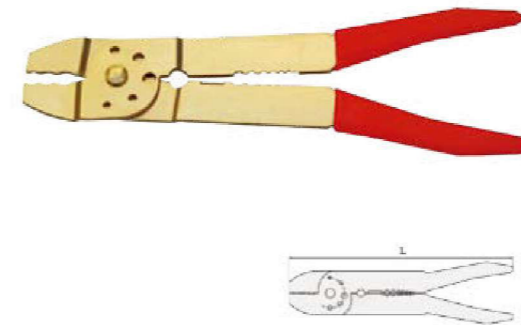

Item No.	L (inch)	L (mm)	Beryllium Copper (g)	Aluminium Bronze (g)
NS257B-1002	8	200	225	205

**NS258** Tweezers, Neat Tips

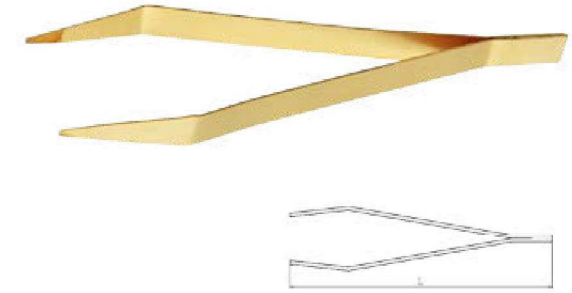

Item No.	L (mm)	Beryllium Copper (g)	Aluminium Bronze (g)
NS258-1002	150	30	25
NS258-1004	200	50	40

**NS257C** Wire Stripping Pliers

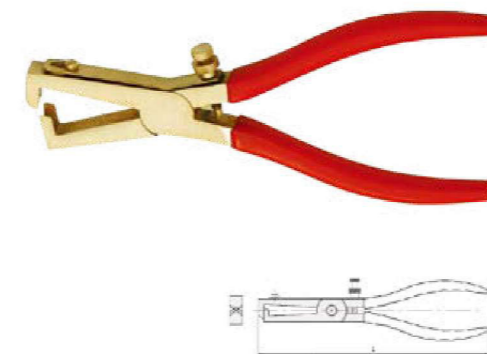

Item No.	L (mm)	Beryllium Copper (g)	Aluminium Bronze (g)
NS257C-1002	170	225	205

**NS258A** Tweezers, Flat Nose

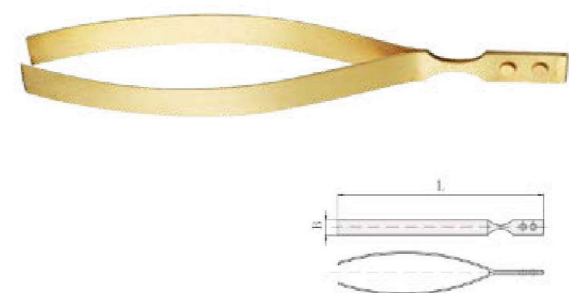

Item No.	L (mm)	B (mm)	Beryllium Copper (g)	Aluminium Bronze (g)
NS258A-1002	100	8	30	25
NS258A-1004	200	15	65	55



### NS259 Slotted Offset Screwdriver

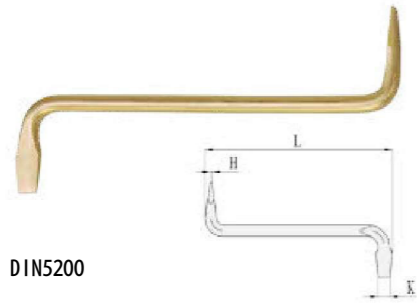

DIN5200

Item No.	L (mm)	H (mm)	K (mm)	Beryllium Copper (g)	Aluminium Bronze (g)
NS259-1002	72	1	6	25	23
NS259-1004	125	1,5	8	55	50
NS259-1006	196	1,5	10	135	124

### NS259A Phillips Offset Screwdriver



Item No.	L (mm)	Size	Beryllium Copper (g)	Aluminium Bronze (g)
NS259A-1002	120	1#*2#	50	45

### NS262 Screwdriver

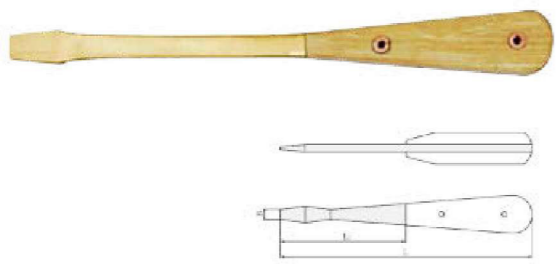

Item No.	L (mm)	L1 (mm)	B (mm)	Beryllium Copper (g)	Aluminium Bronze (g)
NS262-1002	200	100	8	135	125
NS262-1004	250	110	8	220	204
NS262-1006	300	160	10	305	275
NS262-1008	500	350	11	505	461

### NS260 Slotted Screwdriver

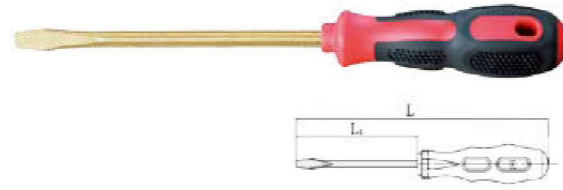

Item No.	L1 (inch)	L1 (mm)	L (mm)	H (mm)	B (mm)	Beryllium Copper (g)	Aluminium Bronze (g)
NS260-1002	2	50	134	0,4	3	35	33
NS260-1004	2	50	134	0,5	4,5	43	40
NS260-1006	3	75	159	0,4	3	35	32
NS260-1008	3	75	159	0,5	4	45	42
NS260-1010	3	75	180	0,6	5	70	65
NS260-1012	4	100	184	0,5	4	45	42
NS260-1014	4	100	205	0,6	5	75	70
NS260-1016	4	100	215	0,8	6	85	80
NS260-1018	5	125	240	0,8	6	100	95
NS260-1020	6	150	265	0,8	6	110	105
NS260-1022	6	150	265	1	7	125	120
NS260-1024	6	150	277	1,2	8	140	135
NS260-1026	8	200	327	1,2	8	165	155
NS260-1028	10	250	377	1,4	9	185	175
NS260-1030	10	250	377	2	11	260	245
NS260-1032	12	300	427	1,8	10	245	230
NS260-1034	12	300	427	2	11	290	275
NS260-1036	14	350	477	2	11	320	300
NS260-1038	16	400	550	2,4	12	450	430

### NS261 Phillips Screwdriver



Item No.	L1 (inch)	Size	L1 (mm)	L (mm)	Φ (mm)	Beryllium Copper (g)	Aluminium Bronze (g)
NS261-1002	2	0	50	134	3	35	32
NS261-1004	3	1	75	159	4	70	63
NS261-1006	4	1	100	205	5	75	70
NS261-1008	5	2	125	240	6	100	95
NS261-1010	6	2	150	265	6	110	105
NS261-1012	8	3	200	327	8	165	155
NS261-1014	10	3	250	377	8	185	170
NS261-1016	12	4	300	427	9	245	230
NS261-1018	14	4	350	477	9	270	255
NS261-1020	16	4	400	550	9	295	280
NS261-1022	18	4	450	600	9	320	300

### NS263 Slotted Screwdriver

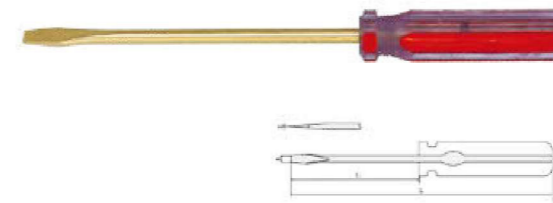

Item No.	L1 (inch)	L1 (mm)	L (mm)	H (mm)	B (mm)	Beryllium Copper (g)	Aluminium Bronze (g)
NS263-1002	2	50	108	0,4	3	35	32
NS263-1004	3	75	133	0,5	3	48	44
NS263-1006	3	75	153	0,5	4	50	45
NS263-1008	3	75	153	0,6	5	51	46
NS263-1010	4	100	178	0,5	4	60	55
NS263-1012	4	100	178	0,6	5	71	65
NS263-1014	4	100	193	0,8	6	77	70
NS263-1016	6	150	243	1	7	115	105
NS263-1018	8	200	305	1,2	8	197	180
NS263-1020	10	250	355	1,4	9	221	202
NS263-1022	12	300	420	1,8	10	304	278
NS263-1024	14	350	470	2	11	365	335

### NS263A Electrician Screwdriver



Item No.	L1 (inch)	L1 (mm)	L (mm)	H (mm)	B (mm)	Beryllium Copper (g)	Aluminium Bronze (g)
NS263A-1002	2	50	134	0,4	3	37	35
NS263A-1004	4	100	184	0,5	4	47	45
NS263A-1006	4	100	215	0,8	6	95	90
NS263A-1008	6	150	277	1,2	8	145	135
NS263A-1010	8	200	327	1,8	10	230	210

### NS263B Driver Hex Nut

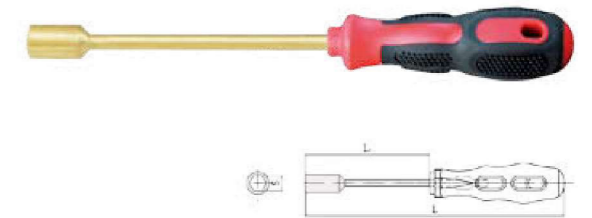

Item No.	L1 (mm)	L (mm)	S (mm)	Beryllium Copper (g)	Aluminium Bronze (g)
NS263B-1002	90	205	6	85	81
NS263B-1004	100	215	8	100	85
NS263B-1006	110	225	10	140	130
NS263B-1008	110	237	13	185	172
NS263B-1010	120	247	16	220	205
NS263B-1012	120	247	17	230	218

### NS264 Pozidriv Screwdriver

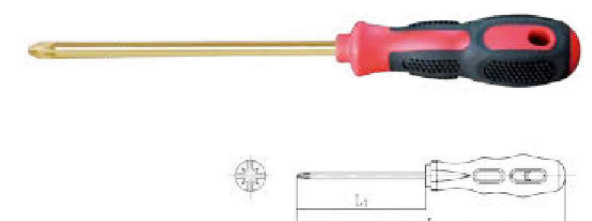

Item No.	L1 (inch)	Size	L1 (mm)	L (mm)	Beryllium Copper (g)	Aluminium Bronze (g)
NS264-1002	2	0	50	134	35	33
NS264-1004	3	1	75	159	45	42
NS264-1006	4	2	100	220	85	80
NS264-1008	6	3	150	277	145	135
NS264-1010	8	4	200	327	230	210

### NS264A Torx Screwdriver

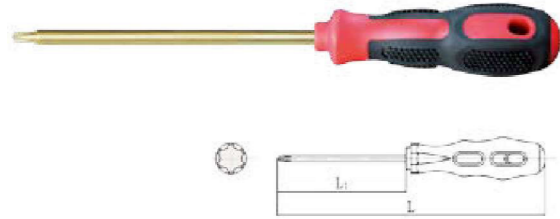

Item No.	Size	L <sub>1</sub> (mm)	L (mm)	Beryllium Copper (g)	Aluminium Bronze (g)
NS264A-1002	T10*75	75	180	70	63
NS264A-1004	T15*75	75	180	70	63
NS264A-1006	T20*100	100	215	100	95
NS264A-1008	T25*125	125	240	105	100
NS264A-1010	T30*150	150	265	110	100
NS264A-1012	T40*200	200	327	165	155
NS264A-1014	T45*250	250	377	185	175
NS264A-1016	T50*300	300	427	205	195
NS264A-1018	T55*350	350	477	245	225
NS264A-1020	T60*400	400	527	280	255

### NS265 Insulated Slotted Screwdriver



Item No.	L <sub>1</sub> (inch)	L <sub>1</sub> (mm)	L (mm)	H (mm)	B (mm)	Beryllium Copper (g)	Aluminium Bronze (g)
NS265-1002	2	50	134	0,4	3	35	33
NS265-1004	2	50	134	0,5	4,5	43	40
NS265-1006	3	75	159	0,4	3	35	32
NS265-1008	3	75	159	0,5	4	45	42
NS265-1010	3	75	180	0,6	5	70	65
NS265-1012	4	100	184	0,5	4	45	42
NS265-1014	4	100	205	0,6	5	75	70
NS265-1016	4	100	215	0,8	6	85	80
NS265-1018	5	125	240	0,8	6	100	95
NS265-1020	6	150	265	0,8	6	110	105
NS265-1022	6	150	265	1	7	125	120
NS265-1024	6	150	277	1,2	8	140	135
NS265-1026	8	200	327	1,2	8	165	155
NS265-1028	10	250	377	1,4	9	185	175
NS265-1030	10	250	377	2	11	260	245
NS265-1032	12	300	427	1,8	10	245	230
NS265-1034	12	300	427	2	11	290	275
NS265-1036	14	350	477	2	11	320	300
NS265-1038	16	400	550	2,4	12	450	430

### NS267 Marking Tool



Item No.	L (mm)	H (mm)	Φ (mm)	Beryllium Copper (g)	Aluminium Bronze (g)
NS267-1002	400	40	12	502	445
NS267-1004	600	50	16	1152	1036

### NS270 Hacksaw Frame

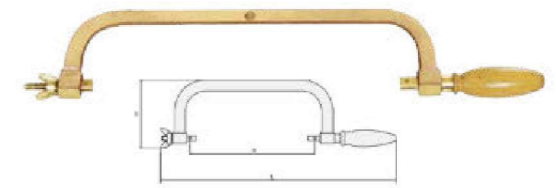

Item No.	L (mm)	D (mm)	H (mm)	Beryllium Copper (g)	Aluminium Bronze (g)
NS270-1002	500	300	110	645	590

### NS268 Marking Tool

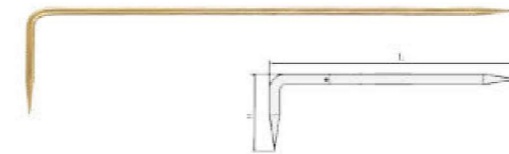

Item No.	L (mm)	H (mm)	Φ (mm)	Beryllium Copper (g)	Aluminium Bronze (g)
NS268-1002	187	32	4	15	10
NS268-1004	252	42	4	20	15

### NS271 Hacksaw Blade

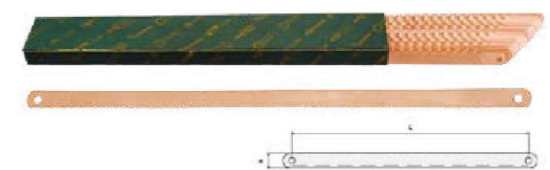

Item No.	L (mm)	B (mm)	Beryllium Copper (g)
NS271-1002	300	12	32

### NS264B Screwdriver Bits



Item No.	Size
NS264B-⓪	4,5mm,6,5mm,8mm
NS264B-⊕	1#,2#,3#,4#
NS264B-⊗	1#,2#,3#,4#
NS264B-●	3mm,4mm,5mm,6mm,7mm,10mm
NS264B-⊛	T10,T15,T20,T25,T27,T30,T40

### NS266 Insulated Phillips Screwdriver



Item No.	L <sub>1</sub> (inch)	Size	L <sub>1</sub> (mm)	L (mm)	Φ (mm)	Beryllium Copper (g)	Aluminium Bronze (g)
NS266-1002	2	0	50	134	3	35	32
NS266-1004	3	1	75	159	4	70	63
NS266-1006	4	1	100	205	5	75	70
NS266-1008	5	2	125	240	6	100	95
NS266-1010	6	2	150	265	6	110	105
NS266-1012	8	3	200	327	8	165	155
NS266-1014	10	3	250	377	8	185	170
NS266-1016	12	4	300	427	9	245	230
NS266-1018	14	4	350	477	9	270	255
NS266-1020	16	4	400	550	9	295	280
NS266-1022	18	4	450	600	9	320	300

### NS269 Awl



Item No.	L <sub>1</sub> (inch)	L <sub>1</sub> (mm)	Φ (mm)	L (mm)	Beryllium Copper (g)	Aluminium Bronze (g)
NS269-1002	4	100	3	184	50	45

### NS272 Hand Saw

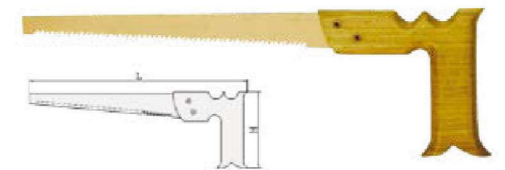

Item No.	L (mm)	H (mm)	Beryllium Copper (g)	Aluminium Bronze (g)
NS272-1002	370	114	125	265

### NS269A Dividers

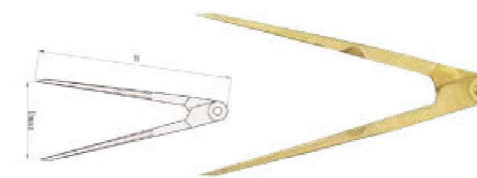

Item No.	D <sub>max</sub> (mm)	H (mm)	Beryllium Copper (g)	Aluminium Bronze (g)
NS269A-1002	200	200	170	150
NS269A-1004	400	400	400	360

### NS272A Hand Saw

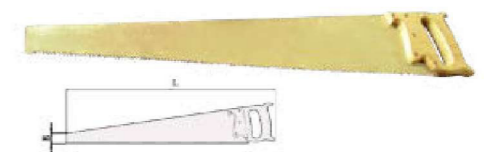

Item No.	L (mm)	H (mm)	Beryllium Copper (g)	Aluminium Bronze (g)
NS272A-1002	700	35	555	520

**NS273** 3 Leg Gear Puller

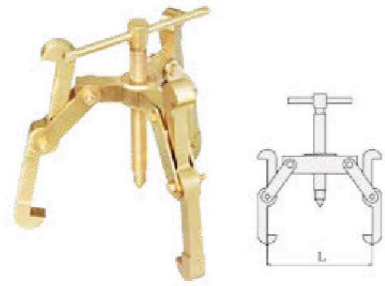

Item No.	L <sub>max</sub> (mm)	Beryllium Copper (g)	Aluminium Bronze (g)
NS273-1002	100	3280	2990
NS273-1004	150	4050	3675
NS273-1006	200	5990	5430
NS273-1008	350	12350	11230

**NS274A** Clamp

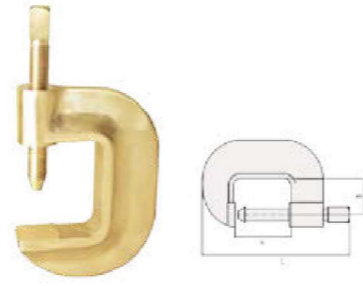

Item No.	L (mm)	K (mm)	B (mm)	Beryllium Copper (g)	Aluminium Bronze (g)
NS274A-1002	76	19	19	200	180
NS274A-1004	290	115	75	5600	5000
NS274A-1006	370	165	90	11100	10000

**NS277** Cleaning Rust Rake

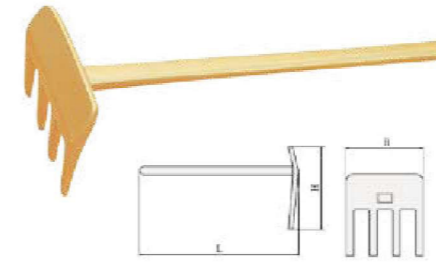

Item No.	L (mm)	H (mm)	B (mm)	Beryllium Copper (g)	Aluminium Bronze (g)
NS277-1002	350	105	98	1050	950

**NS280** Oil Dipper

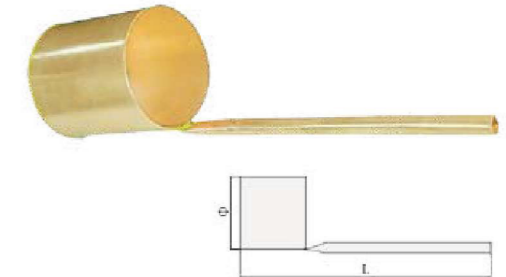

Item No.	Φ (mm)	L (mm)	ΔT (g)
NS280-1002	85	350	163

**NS273A** 2 Leg Gear Puller

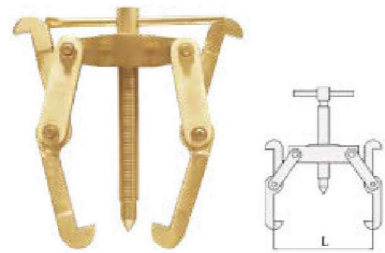

Item No.	L <sub>max</sub> (mm)	Beryllium Copper (g)	Aluminium Bronze (g)
NS273A-1002	100	2765	2500
NS273A-1004	150	3450	3120
NS273A-1006	200	5130	4640
NS273A-1008	350	10560	9545

**NS275** Fork, Three Prong

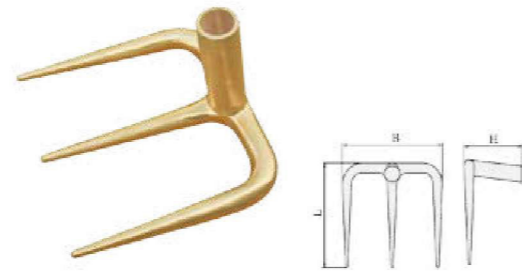

Item No.	L (mm)	B (mm)	H (mm)	Beryllium Copper (g)	Aluminium Bronze (g)
NS275-1002	185	200	125	1690	1540

**NS278** Oil Funnel



Item No.	Φ (mm)	H (mm)	ΔT (g)
NS278-1002	160	130	260
NS278-1004	160	150	280

**NS281** Bucket

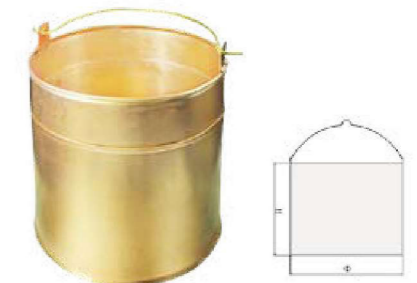

Item No.	Φ (mm)	H (mm)	ΔT (g)
NS281-1002	270	248	1515

**NS274** Clamp

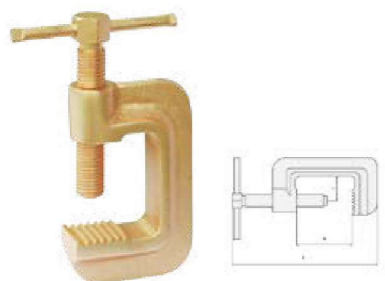

Item No.	L (mm)	K (mm)	B (mm)	Beryllium Copper (g)	Aluminium Bronze (g)
NS274-1002	210	60	36	1200	1080
NS274-1004	250	80	36	1400	1270
NS274-1006	290	100	36	1610	1460
NS274-1008	340	150	50	2155	1970

**NS276** Fork, Four Prong

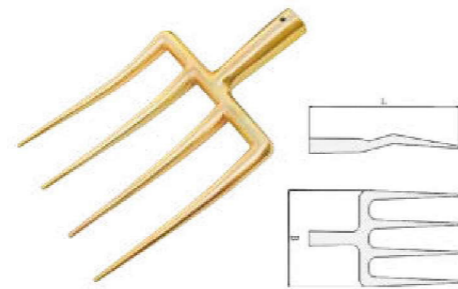

Item No.	L (mm)	B (mm)	Beryllium Copper (g)	Aluminium Bronze (g)
NS276-1002	327	200	2150	1965

**NS279** Portable Oil Pump

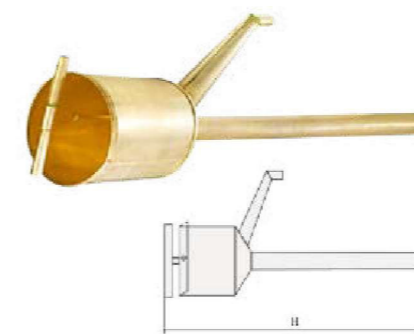

Item No.	Φ (mm)	H (mm)	ΔT (g)
NS279-1002	165	1100	2315

**NS282** Dustpan

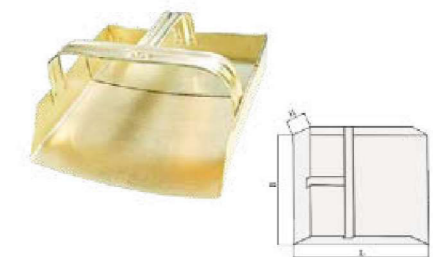

Item No.	L (mm)	B (mm)	H (mm)	ΔT (g)
NS282-1002	150	130	20	130
NS282-1004	200	200	50	335
NS282-1006	270	250	50	635



NS283 Scoop, Sugar



Item No.	L (mm)	H (mm)	Φ <sub>1</sub> (mm)	Φ <sub>2</sub> (mm)	ΔT (g)
NS283-1002	350	90	160	135	580

NS283C Strainer



Item No.	Φ (mm)	H (mm)	ΔT (g)
NS283C-1002	300	600	1800

NS285A Brush



Item No.	L*B (mm)	Rows	H (mm)	Brass (g)	Phosphor Copper (g)
NS285A-1002	350*28	4*19	30	150	150

NS286B Brush, spark-plug cleaning

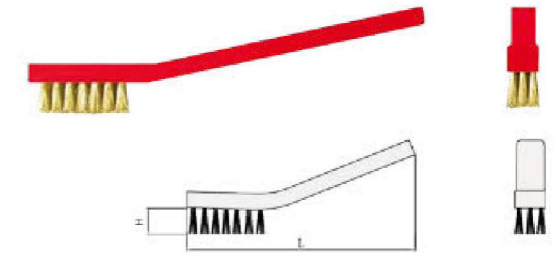

Item No.	L (mm)	Rows	H (mm)	Brass (g)	Phosphor Copper (g)
NS286B-1002	196	3*7	13	20	20

NS283A Scoop, Sugar

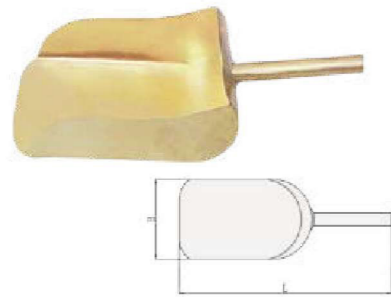

Item No.	B (mm)	L (mm)	ΔT (g)
NS283A-1002	75	200	200
NS283A-1004	140	360	645

NS284 Brush, Flat Back, Scratch

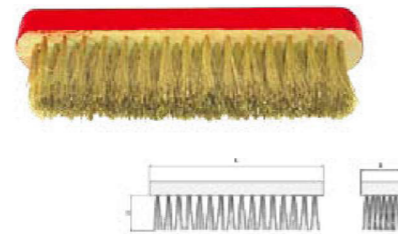

Item No.	L*B (mm)	Rows	H (mm)	Brass (g)	Phosphor Copper (g)
NS284-1002	205*48	6*16	41	260	260

NS286 Brush



Item No.	L*B (mm)	Rows	H (mm)	Brass (g)	Phosphor Copper (g)
NS286-1002	215*29	6*15	15	30	30

NS286C Broom, Round Wire

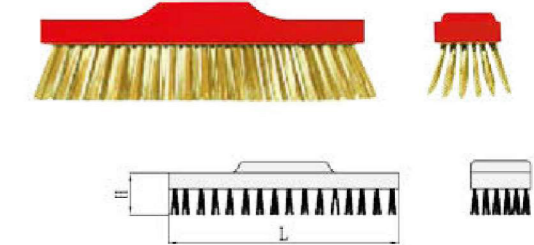

Item No.	L (mm)	Rows	H (mm)	Brass (g)	Phosphor Copper (g)
NS286C-1002	310	6*25	55	1550	1550

NS283B Scoop

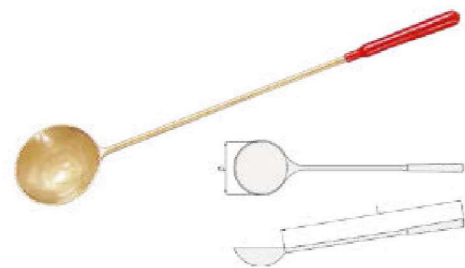

Item No.	Φ (mm)	L (mm)	Beryllium Copper (g)	Aluminium Bronze (g)
NS283B-1002	112	500	1220	1100

NS285 Brush



Item No.	L*B (mm)	Rows	H (mm)	Brass (g)	Phosphor Copper (g)
NS285-1002	290*29	4*16	28	115	115

NS286A Brush, Shoe Handle

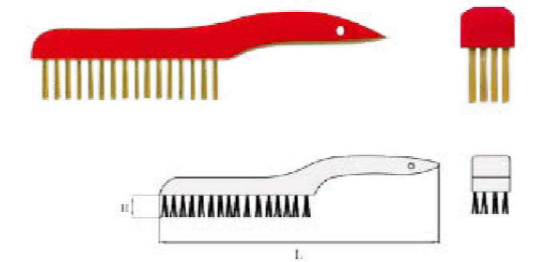

Item No.	L (mm)	Rows	H (mm)	Brass (g)	Phosphor Copper (g)
NS286A-1002	255	4*16	30	180	180

NS286D Scrubbing Broom, round wire

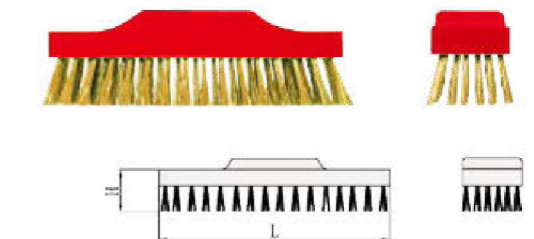

Item No.	L (mm)	Rows	H (mm)	Brass (g)	Phosphor Copper (g)
NS286D-1002	210	6*17	40	500	500

NS287 Brush, Tube

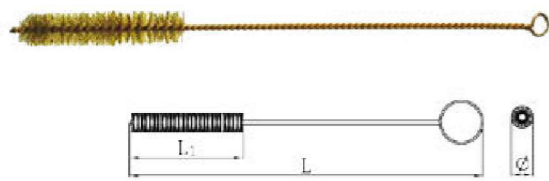

Item No.	Φ (mm)	L <sub>1</sub> (mm)	L (mm)	Brass (g)	Phosphor Copper (g)
NS287-1002	20	100	320	100	100

NS289A Brush, Wheel, Crimped Wire

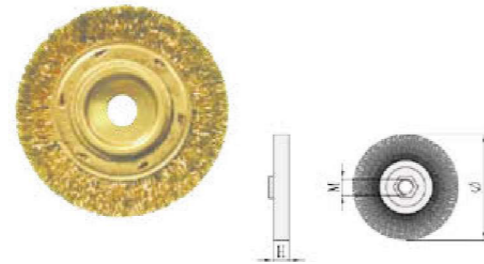

Item No.	Φ (mm)	H (mm)	M (mm)	Brass (g)	Phosphor Copper (g)
NS289A-1002	125	15	14	320	320

NS290B Brush, End



Item No.	Φ (mm)	L (mm)	Φ <sub>1</sub> (mm)	Brass (g)	Phosphor Copper (g)
NS290B-1002	26	25	6	120	120

NS292 Shackle

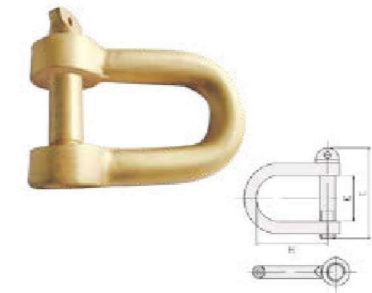

Item No.	Size	K (mm)	L (mm)	H (mm)	Beryllium Copper (g)	Aluminium Bronze (g)
NS292-1002	1/2	30	60	40	135	130
NS292-1004	3/4	37	99	78	915	830

NS288 Brush, Wheel

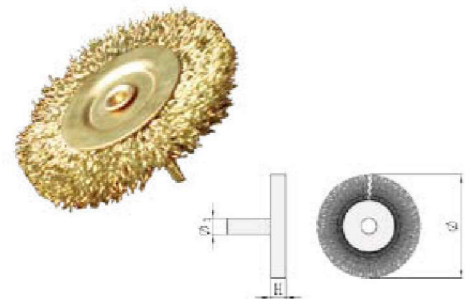

Item No.	Φ (mm)	H (mm)	Φ <sub>1</sub> (mm)	Brass (g)	Phosphor Copper (g)
NS288-1002	75	10	6	140	140

NS290 Brush, Cup

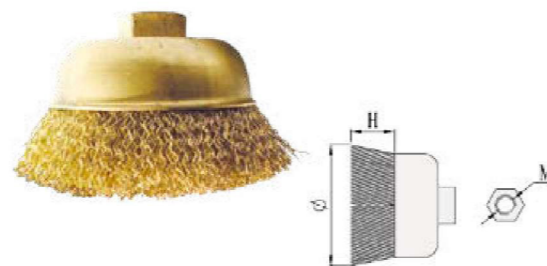

Item No.	Φ (mm)	H (mm)	M (mm)	Brass (g)	Phosphor Copper (g)
NS290-1002	100	30	14	480	480

NS290C Brush, Ball

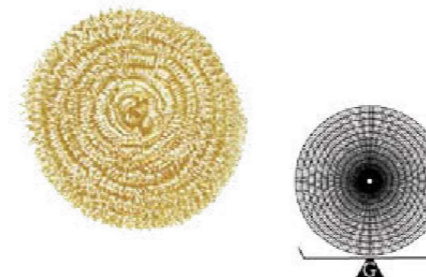

Item No.	ΔΦ (g)
NS290C-1002	25

NS293 Manual Portable Oil Pump



Item No.	L (mm)	Beryllium Copper (g)	Aluminium Bronze (g)
NS293-1002	1350	6000	5700

NS289 Wheel Brush, knot Wire

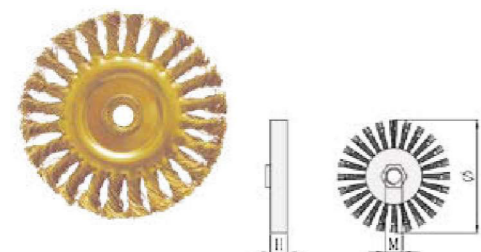

Item No.	Φ (mm)	H (mm)	Φ <sub>1</sub> (mm)	Brass (g)	Phosphor Copper (g)
NS289-1002	125	15	14	440	440

NS290A Cup Brush, knot wire

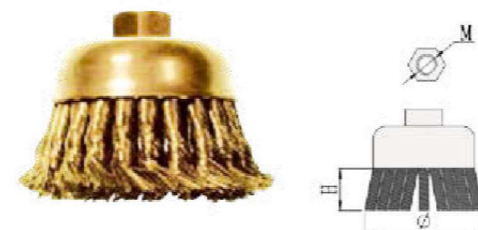

Item No.	Φ (mm)	H (mm)	M (mm)	Brass (g)	Phosphor Copper (g)
NS290A-1002	100	30	14	580	580

NS291 Hoe



Item No.	B (mm)	H (mm)	Beryllium Copper (g)	Aluminium Bronze (g)
NS291-1002	130	130	1080	970
NS291-1004	200	200	1780	1600

NS294 Barrel Hook, Adjustable



Item No.	H (kg)	K (mm)	Beryllium Copper (g)	Aluminium Bronze (g)
NS294-1002	700	1060	3300	3050

NS295 Screw Clamp

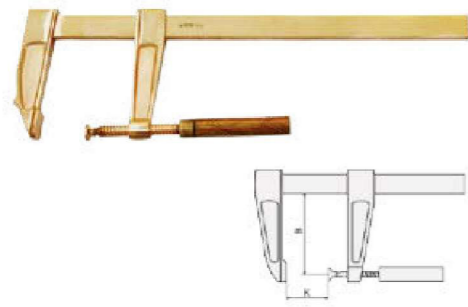

Item No.	B (mm)	K <sub>max</sub> (mm)	Beryllium Copper (g)	Aluminium Bronze (g)
NS295-1002	120	400	2395	2200

NS296 Rake

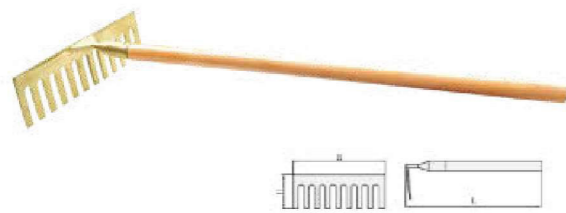

Item No.	L (mm)	B (mm)	H (mm)	Beryllium Copper (g)	Aluminium Bronze (g)
NS296-1002	1270	350	100	2080	1935
NS296-1004	1275	450	120	2300	2135

NS297 Chisel

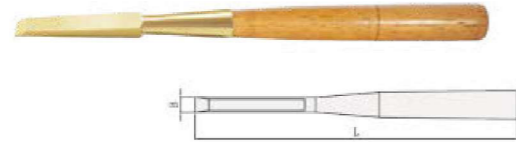

Item No.	B (mm)	L (mm)	Beryllium Copper (g)	Aluminium Bronze (g)
NS297-1002	14	280	200	180
NS297-1004	18	320	270	250

NS298 Rake

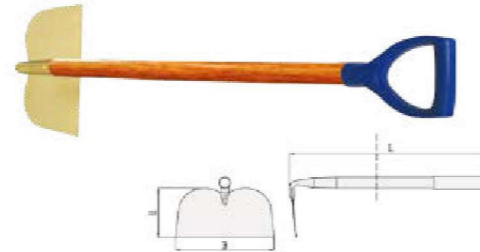

Item No.	B (mm)	H (mm)	Beryllium Copper (g)	Aluminium Bronze (g)
NS298-1002	300	150	1550	1400

NS299 Rake



Item No.	L (mm)	B (mm)	H (mm)	Beryllium Copper (g)	Aluminium Bronze (g)
NS299-1002	780	160	80	670	600

NS300 Fire Hook



Item No.	L (mm)	L <sub>1</sub> (mm)	Beryllium Copper (g)	Aluminium Bronze (g)
NS300-1002	270	1215	1365	1300

NS301 Self Locking Pipe Vice

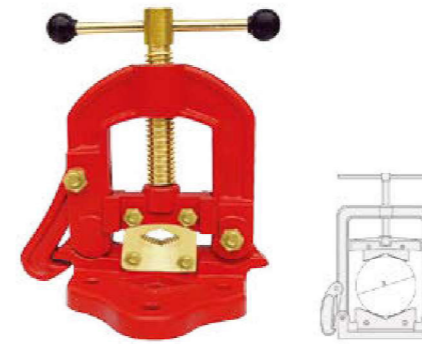

Item No.	D (mm)	Beryllium Copper (g)	Aluminium Bronze (g)
NS301-1002	10-60	4870	4425
NS301-1004	10-90	10350	9420
NS301-1006	15-115	15300	13900
NS301-1008	30-220	30600	27800
NS301-1010	30-300	38000	35000

NS305 Pipe Cutter



Item No.	D (inch)	D (mm)	Beryllium Copper (g)	Aluminium Bronze (g)
NS305-1002	2	50	2210	2010
NS305-1004	3	70	4070	3700

NS306 Hydraulic Pallet Truck

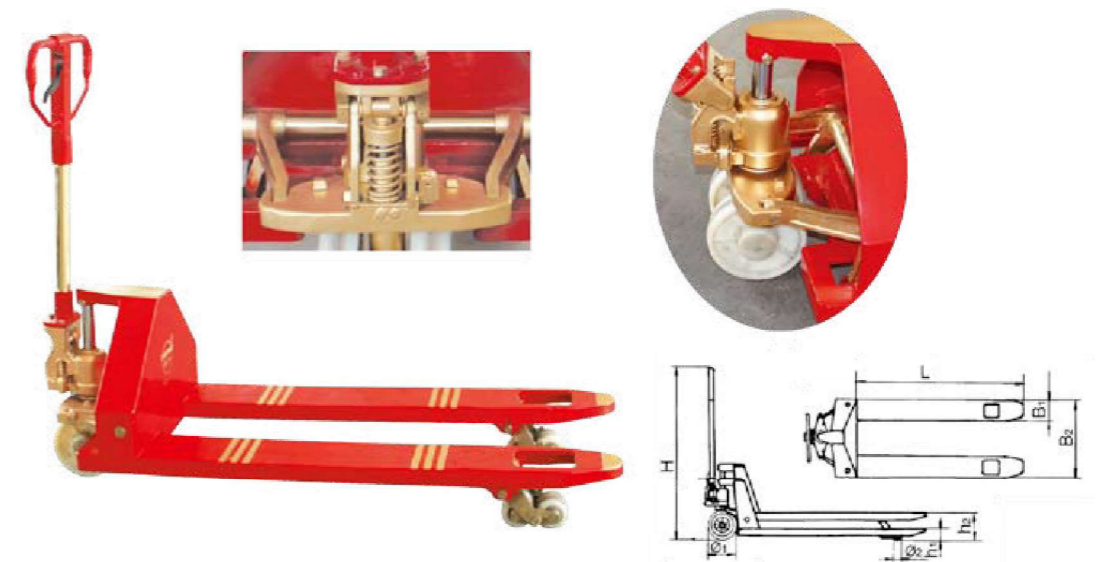

Item No.	Load (kg)	L (mm)	H (mm)	B <sub>1</sub> (mm)	B <sub>2</sub> (mm)
NS306-1002	2000	1190	1240	160	545
	h <sub>1</sub> (mm)	h <sub>2</sub> (mm)	Φ <sub>1</sub> (inch)	Φ <sub>2</sub> (inch)	Weight (kg)
	90	190	7	3	132



**NS307** Trolley For Chain Hoist (Pull Type)



Size:FBGCL

Item No.	Capacity (T)	Liftii (m)	I-Beam Width (m)	ΔTΔ (kg)
NS307-1002	0,5	2,5	68-94	16,5
NS307-1004	1	2,5	68-100	20
NS307-1006	2	2,5	94-124	26
NS307-1008	3	3	116-140	27,5
NS307-1010	5	3	142-180	34
NS307-1012	10	3	142-180	68
NS307-1014	16	3	142-180	170

**NS307A** Trolley For Chain Hoist (Pull Type)



Size:FBGCT

Item No.	Capacity (T)	I-Beam Width (m)	ΔTΔ (kg)
NS307A-1002	0,5	68-94	13
NS307A-1004	1	68-100	16,5
NS307A-1006	2	94-124	22
NS307A-1008	3	116-140	23,5

**NS308** Chain Hoist



Size:FBHS

Item No.	Capacity (T)	Liftii (m)	ΔTΔ (kg)
NS308-1002	0,5	2,5	10,2
NS308-1004	1	2,5	13,6
NS308-1006	2	2,5	22
NS308-1008	3	3	23,6
NS308-1010	5	3	36
NS308-1012	10	3	68,5
NS308-1014	16	3	187

**NS308A** Chain Hoist



Size:FBHSA

Item No.	Capacity (T)	Liftii (m)	ΔTΔ (kg)
NS308A-1002	0,5	2,5	11,4
NS308A-1004	1	2,5	18,4
NS308A-1006	2	2,5	27,9
NS308A-1008	3	3	28,3
NS308A-1010	5	3	54

**NS308B** Ratchet lever Hoist



Item No.	Capacity (T)	Liftii (m)	ΔTΔ (kg)
NS308B-1002	0,75	1,5	7,7
NS308B-1004	1,5	1,5	11,8
NS308B-1006	3	1,5	21

**NS308C** Come Along



Item No.	Size (T)	ΔTΔ (kg)
NS308C-1002	1	3
NS308C-1004	2	4,5
NS308C-1006	3	6,3

**NS309** Torque Wrench



Item No.	C (inch)	Torque (N. m)	L (mm)	Beryllium Copper (g)	Aluminium Bronze (g)
NS309-1002	3/8	100	310	600	540
NS309-1004	1/2	300	490	1340	1210
NS309-1006	3/4	500	560	2050	1930

**NS310** Flange Prop



Item No.	Size (mm)	Beryllium Copper (g)	Aluminium Bronze (g)
NS310-1002	FZM16-24	7300	6600
NS310-1004	FZM27-36	9900	9000

**NS307B** Trolley For Chain Hoist (Pull Type)



Size:FBGCL

Item No.	Capacity (T)	Liftii (m)	I-Beam Width (m)	ΔTΔ (kg)
NS307B-1002	0,5	2,5	68-94	12,5
NS307B-1004	1	2,5	68-100	14,5
NS307B-1006	2	2,5	94-124	22,3
NS307B-1008	3	3	116-140	24
NS307B-1010	5	3	142-180	34
NS307B-1012	10	3	142-180	68
NS307B-1014	16	3	142-180	170
NS307B-1016	20	3	142-180	170

### NS311 Parallel Vice

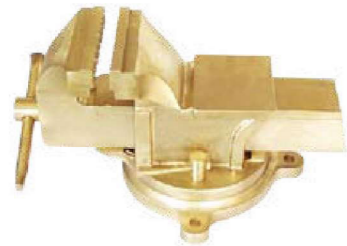

Item No.	B (mm)	K <sub>max</sub> (mm)	Beryllium Copper (g)	Aluminium Bronze (g)
NS311-1002	90	90	8150	7400
NS311-1004	125	125	19550	16800
NS311-1006	150	150	30000	26500
NS311-1008	170	170	30300	27400

### NS311A Chisel

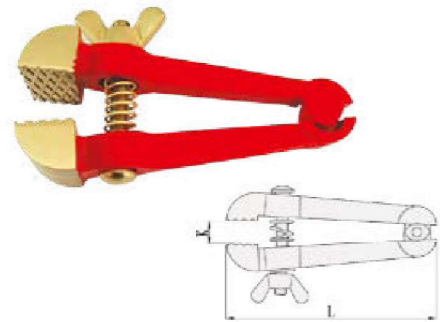

Item No.	K (mm)	L (mm)	Beryllium Copper (g)	Aluminium Bronze (g)
NS311A-1002	50	165	915	830

### NS312 Drill Bit



Item No.	Φ (mm)	L (mm)	Beryllium Copper (g)
NS312-1002	6	100	20
NS312-1004	7	120	30
NS312-1006	8	140	50
NS312-1008	9	160	75
NS312-1010	10	180	100
NS312-1012	11	200	120
NS312-1014	12	220	170
NS312-1016	13	240	220
NS312-1018	14	260	280
NS312-1020	15	280	360
NS312-1022	16	300	440
NS312-1024	17	300	500
NS312-1026	18	320	600
NS312-1028	19	320	700
NS312-1030	20	330	800

### NS313 Releasing Static Device



Item No.	L (mm)	D (mm)	Aluminium Bronze (g)
NS313-1002	1150	65	3700

### NS313A Releasing Static Device



Item No.	L (mm)	D (mm)	Aluminium Bronze (g)
NS313A-1002	1150	65	3800

### Instruction:

Before entering flammable or explosive hazardous atmosphere, switch on the static discharger and touch the ball head on the top. If the human static electricity voltage exceeds safety level, the indicator light will turn red and the buzzer alarms automatically. Then en-



continuously touch the ball for 10 to 15 seconds till nothing happens, the human body are in secure state.

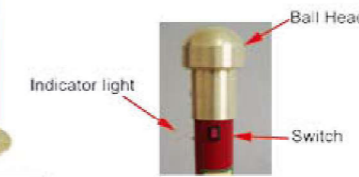

### NS314 Screw Jack



Item No.	Model	Capacity (T)	MIN. H (m)	Lift H (m)
NS314-1002	FBQL3,2	3,2	220	110
NS314-1004	FBQL 5	5	250	130
NS314-1006	FBQL10	10	280	150
NS314-1008	FBQL16	16	320	180

### NS315 Packing tool



Item No.	Beryllium Copper (g)	Aluminium Bronze (g)
NS315-1002	900	800



**NS A** Double Open End Wrench Set

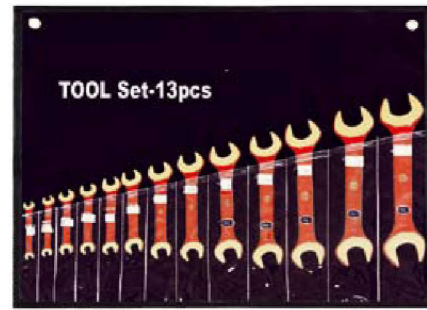

Tool:	Descriptio (mm)
NSA-9	8*10,10*12,12*14,14*17,17*19,19*22,22*24,24*27,30*32
NSA-10	8*10,10*12,12*14,14*17,17*19,19*22,22*24,24*27,27*30,30*32
NSA-11	8*10,9*11,10*12,12*14,14*17,17*19,19*22,22*24,24*27,27*30,30*32
NSA-13	5,5*7,6*7,8*10,9*11,10*12,12*14,14*17,17*19,19*22,22*24,24*27,27*30,30*32

**NS C** Double Box Offset Wrench Set



Tool:	Descriptio (mm)
NSC-9	8*10,10*12,12*14,14*17,17*19,19*22,22*24,24*27,30*32
NSC-10	8*10,10*12,12*14,14*17,17*19,19*22,22*24,24*27,27*30,30*32
NSC-11	8*10,9*11,10*12,12*14,14*17,17*19,19*22,22*24,24*27,27*30,30*32
NSC-13	5,5*7,6*7,8*10,9*11,10*12,12*14,14*17,17*19,19*22,22*24,24*27,27*30,30*32

**NS E-9** Tool Set-9pcs



L\*W\*H:400\*290\*90mm

Tool:	Descriptio
Wrench,Adjustable	300mm
Pliers,Lineman	200mm
Pliers,Groove Joint	250mm
Slotted Screwdriver	150mm,200mm
Phillips Screwdriver	150mm,200mm
Hammer,Cross Pein Engineers	1kg
Knife,Putty	50mm*200mm

**NS G-16** Tool Set-16pcs



Tool:	Descriptio
Wrench,Double Box	8*10,10*12,14*17,19*22mm
Wrench,Adjustable	250mm
Wrench,Pipe	350mm
Pliers,Water Pump	250mm
Pliers,Adjustable,Combination	150mm,200mm
Slotted Screwdriver	150mm
Phillips Screwdriver	150mm
Hammer,Claw	0,45kg
Knife,Putty	25*200mm
Knife,Common	250mm
Scraper,Deck	45*300mm
Brush	4*16mm

**NS B** Combination Wrench Set



Tool:	Descriptio (mm)
NSB-9	8,10,12,14,17,19,22,24,27
NSB-10	10,12,14,17,19,22,24,27,30,32
NSB-11	8,10,12,14,17,19,22,24,27,30,32
NSB-13	8,10,12,13,14,16,17,19,22,24,27,30,32

**NS D-15** Drill Bit Set-15pcs



L\*W\*H:400\*290\*70mm

Tool:	Descriptio
Drill Bit	6*100mm,7*120mm,8*140mm,
	9*160mm,10*180mm,11*200mm
	12*220mm,13*240mm,14*260mm
	15*280mm,16*300mm,17*300mm
	18*320mm,19*320mm
	20*330mm

**NS F-15** Tool Set-15pcs



L\*W\*H:400\*290\*90mm

Tool:	Descriptio
Wrench,Double Open End	8*10mm,10*12mm,12*14mm,14*17mm,17*19mm,19*22mm,22*24mm,24*27mm,30*32mm
Wrench,Adjustable	250mm
Pliers,Lineman	200mm
Pliers,Snipe Nose	200mm
Slotted Screwdriver	200mm
Phillips Screwdriver	200mm
Hammer,Ball Pein	0,91kg

**NS H-17** Tool Set-17pcs



Tool:	Descriptio
Wrench,Pipe	350mm
Wrench,Adjustable	200mm,300mm
Wrench,Combination	14mm,17mm,19mm,22mm,24mm,27mm
Pliers,Lineman	200mm
Pliers,Long Nose	200mm
Pliers,Adjustable Combination	200mm
Punch,Machinists	φ18*160mm
Chisel,Flat	φ18*160mm
Slotted Screwdriver	150mm
Phillips Screwdriver	150mm
Hammer,Ball Pein	0,91Kg



**NS I-26** Tool Set-26pcs



Tool:	Descriptio
Chisel Flat	18*180mm
Wrench,Adjustable	150mm
Pliers, Lineman	200mm
Pliers,Adjustable Combination	200mm
Pliers, Snipe Nose	150mm
Phillips Screwdriver	150mm,200mm
Slotted Screwdriver	150mm,200mm
Socket(1/2")Dr	8mm,10mm,12mm,14mm,17mm
Sliding T Handle	1/2"*250mm
Hammer,Testing	0,15kg
Wrench,Combination	8mm,10mm,12mm,14mm,17mm
Wrench,Hex Key	4mm,5mm,6mm,8mm,10mm

**NS K-28** Tool Set-28pcs



Tool:	Descriptio
Hammer,Sledge	1,8kg
Hammer,Ball Pein	0,91Kg
Hammer,Claw	0,45kg
Wrench,Pipe	300mm,450mm
Wrench,Adjustable	200mm,300mm
Wrench,Combination	8mm,10mm,12mm,14mm,17mm,19mm,22mm,24mm,27mm,30mm,32mm
Pliers, Lineman	200mm
Pliers,Long Nose	200mm
Pliers,Adjustable Combination	200mm
Bar,Pinch	φ25*300mm
Chisel,Flat	φ25*300mm
Slotted Screwdriver	100mm,200mm
Phillips Screwdriver	100mm,200mm
Valve Handle	400mm

**NS L-36** Tool Set-36pcs



L\*W\*H :650\*450\*140m m

Tool:	Descriptio
Hammer,Sledge	1,8kg
Hammer,Ball Pein	0,91kg
Wrench,Pipe	450mm
Wrench,Adjustable	150mm,200mm
Wrench,Combination	10mm,8mm
Pliers, Lineman	200mm,150mm
Pliers,Snipe Nose	150mm
Pliers,Adjustable,Combination	200mm
Pliers,Round Nose	150mm
Pliers,Flat Nose	150mm
Pliers,Diagonal Cutting	150mm
Slotted Screwdriver	75mm,100mm,150mm,200mm
Phillips Screwdriver	75mm,100mm,150mm,200mm
Slotted Offset Screwdriver	6*72mm,8*125mm,10*196mm
Chisel 8 Point	16*160mm
Shears,Cutting	150mm
Knife,Common	250mm
Knife,Putty	50*200mm
Tweezers,Neat Tips	200mm
Bar	19*500mm
Marking Tool	250mm
Bar,Wrecking	400mm
Hacksaw Frame	500mm
Hacksaw Blade	300mm
Brush,Flat Back,Scratch	6*16mm

**NS M-40** Tool Set-40pcs



L\*W\*H :570\*370\*210m m

Tool:	Descriptio
Hammer,Sledge	1kg
Hammer,Claw	0,23kg
Hammer,Ball Pein	0,45kg
Wrench,Pipe	200mm
Wrench,Adjustable	150mm,250mm
Pliers, Lineman	150mm
Pliers,Snipe Nose	150mm
Pliers,Flat Nose	150mm
Pliers,Diagonal Cutting	150mm
Pliers,Adjustable,Combination	150mm
Pincers	200mm
Shears,Cutting	150mm
Slotted Screwdriver	75mm,100mm,150mm
Phillips Screwdriver	75mm,100mm,150mm,
Slotted Offset Screwdriver	6*72mm,8*125mm,10*196mm
Wrench,Hex Key	3mm,4mm,5mm,6mm,7mm,8mm
Chisel 6 Point	16*160mm
Bar,Wrecking	250mm
Knife,Common	250mm
Knife,Putty	25*200mm
Tweezers,Neat Tips	150mm
File,Triangle	200mm
Hearing Needle	6*250mm
Marking Tool	250mm
Hand Saw	370mm
Hacksaw Frame	500mm
Hacksaw Blade	300mm
Brush	6*16mm

**NS J-26** Tool Set-26pcs



L\*W\*H:650\*400\*140mm

Tool:	Descriptio
Wrench,Pipe	450mm,250mm
Wrench,Adjustable	375mm,300mm
Hammer,Ball Pein	0,91kg
Pliers, Lineman	200mm
Pliers,Snipe Nose	200mm
Slotted Screwdriver	400mm,200mm
Phillips Screwdriver	400mm,200mm
Valve Handle	500mm
Wrench,Double Box	30*27mm,27*24mm,24*22mm,22*19mm,19*17mm,17*14mm
Wrench,Double Open End	30*32mm,27*30mm,24*27mm,22*24mm,19*22mm,17*19mm

**NS N-56** Tool Set-56pcs



L\*W\*H:650\*450\*150mm

Tool:	Descriptio
Wrench,Double Open End	5,5*7,6*7,8*10,9*11,10*12,12*14,14*17,17*19,19*22,22*24,24*27,27*30,30*32mm
Wrench,Hex Key	2mm,3mm,4mm,5mm,6mm,7mm,8mm,10mm
Slotted Screwdriver	50mm,75mm,100mm,150mm
Phillips Screwdriver	50mm,75mm,100mm,150mm
Wrench,Adjustable	250mm
Tweezers,Neat Tips	150mm
Pliers, Lineman	150mm
Pliers,Snipe Nose	150mm
Pliers,Groove Joint	250mm
Torque Wrench	1/4",3/8"
1/4"Socket	4mm,5mm,6mm,7mm,8mm,9mm,10mm,11mm
3/8"Socket	10mm,11mm,12mm,13mm,14mm,17mm,19mm
Driver Type Handle	1/4"
Ratchet Wrench	3/8"
Straight Joint	3/8"
Driver Extension	3/8"*75mm
Spark Plug	

**NS 0-50** Tool Set-50pcs



Tools	Descriptio
Hammer,Sledge	1,8kg
Hammer,Ball Pein	0,91kg
Hammer,Claw	0,45kg
Wrench,Pipe	300mm,450mm
Wrench,Adjustable	200mm*24mm,300mm*36mm
Wrench,Combination	8mm,10mm,12mm,14mm,17mm,19mm,22mm,24mm,27mm,30mm,32mm
Pliers,Lineman	200mm
Pliers,Long Nose	200mm
Pliers,Adjustable Combination	200mm
Bar,Pinch	Φ25*300mm
Chisel,Flat	Φ25*300mm
Punch,Machinists	Φ20*300mm
Slotted,Screwdriver	100mm,200mm
Phillips,Screwdriver	100mm,200mm
Valve,Handle	400mm
Knife,Common	250mm
Hacksaw Frame	500mm
Hacksaw Blade	300mm
1/2"Socket	10mm,11mm,12mm,14mm,17mm,19mm,22mm,24mm,27mm,30mm,32mm
Ratchet Wrench	250mm
Driver Extension	125mm,250mm
Speed Handle	400mm
Sliding T Handle	250mm
Universal Joint	1/2"
Putty Knife	25*200mm

**NS P-62** Tool Set-62pcs



Tools	Descriptio
Wrench,Adjustable	200mm,250mm,300mm
Wrench,Combination	8mm,10mm,12mm,14mm,17mm,19mm,22mm,24mm,27mm
Wrench,Combination	3/8",1/2",9/16",5/8",11/16",3/4",13/16",7/8",1"
Wrench,Pipe	200mm,350mm
Pliers,Groove Joint	250mm
Pliers,Adjustable,Combination	150mm,200mm,
Pliers,Lineman	200mm
Pliers,Snipe Nose	150mm
Slotted Screwdriver	75mm,100mm,150mm,200mm,
Phillips Screwdriver	75mm,100mm,150mm,200mm,
Bar,Wrecking	400mm
Bar,Pinch	Φ19*500mm
Knife,Common	250mm
Knife,Putty	40*200mm,50*200mm,100*200mm
Scraper,Deck	350mm
Wrench,Bung	385mm
Chisel,Flat	16*160mm,18*200mm
Hammer,Cross Pein Engineers	0,5kg,1kg
Hammer,Claw	0,45kg
1/2"Socket	8mm,10mm,13mm,14mm,16mm,17mm,19mm,21mm,22mm,26mm
Driver Extension	200mm
Ratchet Wrench	245mm
Hinged Handle	250mm

**NS Q-100** Tool Set-100pcs



L\*W\*H :625\*375\*745m m

Tools	Descriptio
Hammer,Ball Pein	0,23kg,0,45kg
Hammer,Claw	0,23kg
Wrench,Adjustable	150mm,200mm,250mm
Wrench,Combination	8mm,10mm,12mm,14mm,17mm,19mm,22mm,24mm,27mm,30mm,32mm
Pliers,Lineman	200mm
Pliers,Snipe Nose	150mm
Pliers,Adjustable Combination	150mm
Pliers,Flat Nose	150mm
Pincers	200mm
Pliers,Round Nose	150mm
Pliers,Diagonal Cutting	200mm
Tweezer,Neat Tips	150mm
Flat 6 Chisel	14*160mm,16*160mm,18*160mm
Centre Punch	Φ16*100mm,Φ18*200mm,Φ20*300mm
Punch,Machinists	Φ18*160mm,Φ18*250mm,Φ20*300mm
Slotted Screwdriver	5*75mm,6*100mm,7*150mm,8*200mm,9*300mm,10*350mm
Phillips Screwdriver	5*75mm,6*150mm,8*250mm,9*300mm
Knife,Common	250mm
Hacksaw Frame	500mm
Hacksaw Blade	300mm
Hand Saw	370mm
Scraper,Flat	35*350mm
File,Half Round With Handle	200mm
File,Flat With Handle	200mm
File,Square With Handle	200mm
File,Triangle With Handle	200mm
1/4"*3/8"Socket	Set-20pcs
3/4"*1"Socket	Set-26pcs
Torch	2"

**NS R-120** Tool Set-120pcs



L\*W\*H :625\*375\*745m m

Tools	Descriptio
Wrench,Combination	8mm,10mm,12mm,13mm,14mm,16mm,17mm,19mm,22mm,24mm,27mm,30mm,32mm
Valve Handle	400mm
Hammer,Sledge	1kg,1,8kg
Hammer,Claw	0,45kg
Hammer,Ball Pein	0,45kg
Wrench,Pipe	150mm,200mm,250mm,300mm,350mm
Wrench,Adjustable	150mm,200mm,250mm,300mm
Pliers,Lineman	150mm,200mm
Pliers,Snipe Nose	150mm,200mm
Pliers,Flat Nose	150mm,200mm
Pliers,Diagonal Cutting	150mm,200mm
Pliers,Adjustable,Combination	150mm,200mm
Pincers	200mm
Shears,Cutting	150mm
Pliers,Groove Joint	250mm
Slotted Screwdriver	75mm,100mm,150mm,200mm
Phillips Screwdriver	75mm,100mm,150mm,200mm
Slotted Offset Screwdriver	6*72mm,8*125mm,10*196mm
Wrench,Hex Key	3mm,4mm,5mm,6mm,7mm,8mm,10mm
Chisel 6 Point	16*160mm
Bar,Wrecking	250mm
Wrench,Bung	350mm
Knife,Common	250mm
Knife,Putty	25*200mm
Tweezers,Neat Tips	150mm
File,Triangle	200mm
Hearing Needle	6*250mm
Marking Tool	250mm
Hand Saw	370mm
Hacksaw Frame	500mm
Hacksaw Blade	300mm
Brush	6*16mm
1/2"Dr Socket	Set-28pcs
3/4"Dr Socket	Set-21pcs



**NS S-176** Tool Set-176pcs



L\*W\*H: 1000\*500\*665mm

Tools	Description	Quantity
Wrench, Combination	6mm, 8mm, 10mm □ 12mm, 13mm, 14mm, 15mm, 16mm, 17mm, 19mm, 22mm, 24mm, 27mm, 30mm, 32mm	2
Wrench, Single Open End	41mm, 42mm, 44mm, 46mm, 48mm, 50mm, 55mm, 60mm	2
Wrench, Double Open End	8*10mm, 9*11mm, 12*14mm, 13*16mm, 16*18mm, 17*19mm, 20*22mm, 21*23mm, 24*27mm, 30*32mm	2
Wrench, Socket L-Type	8mm, 10mm, 12mm, 13mm, 14mm, 15mm, 16mm, 17mm, 19mm, 22mm, 24mm, 27mm, 30mm, 32mm	2
Wrench, Hex Key	8mm, 10mm, 12mm, 13mm, 14mm, 17mm, 19mm, 22mm	2
Wrench, Adjustable	200mm, 300mm	2
Slotted Screwdriver	100mm, 150mm, 200mm	2
Phillips Screwdriver	100mm, 150mm, 200mm	2
Pliers, Lineman	200mm	2
Pliers, Groove Joint	250mm	2
Wrench, Striking Box	22mm, 24mm, 27mm, 30mm, 32mm, 34mm, 36mm, 38mm, 41mm, 46mm, 50mm, 55mm, 60mm, 65mm, 70mm,	2
Chisel, Hex 6 Point	14*160mm	3
Punch, Machinists	14*150mm	3
Brush, Flat Back, Scratch	205*48mm	3
Brush	290*29mm	3
Hammer, Sledge	1kg, 1.8kg, 2.7kg, 4.5kg	1

**NS S-A** Hex Key Wrench Set



Tools	Description
Set-9	2,3,4,5,6,7,8,9,10mm
Set-11	2,3,4,5,6,7,8,9,10,11,12mm
Set-13	2,3,4,5,6,7,8,9,10,11,12,13,14mm

**NS T-6** Tool Set-6pcs



Tools	Description
Slotted Screwdriver	5/16" * 3"
Phillips Screwdriver	#2 * 4"
Wrench, Adjustable	8"
Crate Opener	230mm
Pliers, Water Pump	10"
Pliers, Adjustable Combination	6"

**NS V-6** Tool Set-6pcs



Tools	Description
Slotted Screwdriver	5/16" * 3", 7/16" * 6", 25/64" * 8"
Phillips Screwdriver	#1 * 3", #2 * 4", #3 * 6"

**NS U-10** Tool Set-10pcs



Tools	Description
Slotted Screwdriver	5/16" * 3"
Phillips Screwdriver	#2 * 4"
Wrench, Adjustable	6", 10"
Hammer, Claw	0,45kg
Pliers, Water Pump	10"
Knife, Putty	1-1/4" * 3-9/16"
Knife, Common	3-1/8"
Pliers, Adjustable Combination	6"
Wrench, Pipe (American Type)	10"

**NS W-21** Tool Set-21pcs



Tools	Description
Socket	5/16", 3/8", 7/16", 1/2", 9/16", 19/32", 5/8", 11/16", 3/4", 25/32", 13/16", 7/8", 15/16", 1", 1-1/16", 1-1/8", 1-1/4",
Hinged Handle	1/2" * 250mm
Ratchet Wrench	1/2" * 245mm
Driver Extension	1/2" * 250mm
Sliding Bar	11"

**NS X-16** Tool Set-16pcs



Tools	Description
Slotted Screwdriver	5/16" * 3"
Phillips Screwdriver	#3 * 6"
Wrench, Adjustable	8", 12"
Hammer, Claw	0,45kg
Crate Opener	230mm
Pliers, Water Pump	10", 12"
Knife, Putty	1-1/4" * 3-9/16"
Knife, Common	3-1/8", 5-3/4"
Pliers, Snipe Nose	7"
Pliers, Adjustable Combination	8"
Scraper, Spray Booth	3"
Scraper, Deck	380mm
Wrench, Pipe (American Type)	14"
Wrench, Bung	300mm
Shears, Tin	12"

**NS Y-34** Tool Set-34pcs



Tools	Description
Wrench, Double Open End	6*7, 8*9, 9*11, 10*12, 11*13, 14*15, 16*18, 17*19, 20*22, 21*23, 24*26, 27*30, 32*36, 1/16", 3/32", 2mm, 3mm, 4mm,
Wrench, Hex Key	5mm, 6mm, 8mm, 10mm
Slotted Screwdriver	8*150, 4*100, 4*75, 3*50
Phillips Screwdriver	3*75, 5*100, 6*150,
Tweezers, Neat Tips	150mm
Pliers, Water Pump	250mm
Wrench, Adjustable	250mm
Pliers, Diagonal Cutting	6"
Pliers, Water Pump	6"



### NS Z-85 Tool Set-85pcs



Tools	Description
Tweezers, Neat Tips	200mm
Marking Tool	200mm
Knife, Common	250mm
Scissors	225mm
Hacksaw Frame	500mm
Hacksaw Blade	300mm
Knife, Putty	40*200
Slotted Screwdriver	3*50, 4, 5*150, 6*100
Phillips Offset Screwdriver	8*150, 10*300
Phillips Screwdriver	6*150, 6*130, 10*140
Phillips Screwdriver	#1*75, #2*125, #3*200
	#4*300
Pliers, Adjustable Combination	200mm
Pliers, Flat Nose	150mm
Pliers, Snipe Nose	150mm
Pliers, Diagonal Cutting	150mm
Wire Stripping Pliers	170mm
Pliers, Round Nose	150mm
Pliers, Lineman	200mm
Wrench, Adjustable	150mm, 250mm
Wrench, Pipe (American Type)	350mm
Hammer, Ball Pein	0,45kg
Club Hammer	4p
Chisel Pneumatic	16*160, 25*230
Bar	16*455
Bar, Wrecking	455mm
Ratchet Wrench	1/2**245
Sliding T Handle	1/2"
Driver Extension	1/2**100, 1/2**250
Universal Joint	1/2"
Socket	10mm, 11mm, 12mm, 13mm, 14mm, 15mm, 17mm, 19mm, 22mm, 24mm, 27mm, 30mm,
Wrench, Hex Key	7/16", 1/2", 9/16"
	5/8", 11/16", 3/4", 13/16"
	7/8", 15/16", 1", 1-1/16", 1-1/8"

### NS2101A Brass Hammer, Sledge



Item No.	Size (lb)	L (mm)	WT (g)
NS2101A-1002	1	350	450
NS2101A-1004	2	400	910
NS2101A-1006	3	400	1400
NS2101A-1008	4	450	1800
NS2101A-1010	5	450	2250
NS2101A-1012	6	800	2700
NS2101A-1014	8	900	3600
NS2101A-1016	10	900	4500
NS2101A-1018	12	900	5400
NS2101A-1020	14	900	6400
NS2101A-1022	16	900	7200
NS2101A-1024	20	900	9000

### NS2101B Brass Hammer, Sledge



Item No.	Size (lb)	L (mm)	WT (g)
NS2101B-1002	1	350	450
NS2101B-1004	2	400	910
NS2101B-1006	3	400	1400
NS2101B-1008	4	450	1800
NS2101B-1010	5	450	2250
NS2101B-1012	6	800	2700
NS2101B-1014	8	900	3600
NS2101B-1016	10	900	4500
NS2101B-1018	12	900	5400
NS2101B-1020	14	900	6400
NS2101B-1022	16	900	7200
NS2101B-1024	20	900	9000

### NS2103A Brass Hammer, Drum Type



Item No.	Size (lb)	L (mm)	WT (g)
NS2103A-1002	1/2	280	230
NS2103A-1004	1	310	450
NS2103A-1006	1-1/2	340	680
NS2103A-1008	2	350	910
NS2103A-1010	3	400	1400
NS2103A-1012	4	400	1800
NS2103A-1014	5	400	2250
NS2103A-1016	6	900	2700
NS2103A-1018	8	900	3600
NS2103A-1020	10	900	4500

### NS2103B Brass Hammer, Drum Type



Item No.	Size (lb)	L (mm)	WT (g)
NS2103B-1002	1/2	280	230
NS2103B-1004	1	310	450
NS2103B-1006	1-1/2	340	680
NS2103B-1008	2	350	910
NS2103B-1010	3	400	1400
NS2103B-1012	4	400	1800
NS2103B-1014	5	400	2250
NS2103B-1016	6	900	2700
NS2103B-1018	8	900	3600
NS2103B-1020	10	900	4500

**NS2102A** Brass Hammer, Mallet



Item No.	Size (lb)	L (mm)	ΔTΔ (g)
NS2102A-1002	1	350	450
NS2102A-1004	2	400	910
NS2102A-1006	3	400	1400
NS2102A-1008	5	450	2250
NS2102A-1010	6	800	2700
NS2102A-1012	8	900	4500
NS2102A-1014	10	900	5400
NS2102A-1016	15	900	7650

**NS2102B** Brass Hammer, Mallet



Item No.	Size (lb)	L (mm)	ΔTΔ (g)
NS2102B-1002	1	350	450
NS2102B-1004	2	400	910
NS2102B-1006	3	400	1400
NS2102B-1008	5	450	2250
NS2102B-1010	6	800	2700
NS2102B-1012	8	900	4500
NS2102B-1014	10	900	5400
NS2102B-1016	15	900	7650

**NS2106A** Brass Hammer, Double face



Item No.	Size (g)	L (mm)	ΔTΔ (g)
NS2106A-1002	500	350	500
NS2106A-1004	1000	400	1000
NS2106A-1006	2000	400	2000
NS2106A-1008	3000	900	3000
NS2106A-1010	5000	900	5000

**NS2106B** Brass Hammer, Double face



Item No.	Size (g)	L (mm)	ΔTΔ (g)
NS2106B-1002	500	350	500
NS2106B-1004	1000	400	1000
NS2106B-1006	2000	400	2000
NS2106B-1008	3000	900	3000
NS2106B-1010	5000	900	5000

**NS2104A** Brass Hammer, Mallet



Item No.	Size (g)	L (mm)	ΔTΔ (g)
NS2104A-1002	500	350	500
NS2104A-1004	1000	400	1000
NS2104A-1006	1500	400	1500
NS2104A-1008	1800	400	1800
NS2104A-1010	2000	400	2000
NS2104A-1012	2700	900	2700
NS2104A-1014	3600	900	3600
NS2104A-1016	4000	900	4000
NS2104A-1018	5000	900	5000

**NS2104B** Brass Hammer, Mallet



Item No.	Size (g)	L (mm)	ΔTΔ (g)
NS2104B-1002	500	350	500
NS2104B-1004	1000	400	1000
NS2104B-1006	1500	400	1500
NS2104B-1008	1800	400	1800
NS2104B-1010	2000	400	2000
NS2104B-1012	2700	900	2700
NS2104B-1014	3600	900	3600
NS2104B-1016	4000	900	4000
NS2104B-1018	5000	900	5000

**NS2107A** Brass Flat Hammer (Euro Type)



Item No.	Size (lb)	L (mm)	ΔTΔ (g)
NS2107A-1002	1	350	450
NS2107A-1004	2	400	910
NS2107A-1006	3	400	1400
NS2107A-1008	5	450	2250
NS2107A-1010	6	900	2700
NS2107A-1012	8	900	4500
NS2107A-1014	10	900	5400
NS2107A-1016	15	900	7650

**NS2107B** Brass Flat Hammer (Euro Type)



Item No.	Size (lb)	L (mm)	ΔTΔ (g)
NS2107B-1002	1	350	450
NS2107B-1004	2	400	910
NS2107B-1006	3	400	1400
NS2107B-1008	5	450	2250
NS2107B-1010	6	900	2700
NS2107B-1012	8	900	4500
NS2107B-1014	10	900	5400
NS2107B-1016	15	900	7650

**NS2105A** Brass Hammer, Ball Pein



Item No.	Size (lb)	L (mm)	ΔTΔ (g)
NS2105A-1002	1/2	280	230
NS2105A-1004	3/4	280	340
NS2105A-1006	1	280	450
NS2105A-1008	1-1/2	310	680
NS2105A-1010	2	340	910
NS2105A-1012	2-1/2	350	1130

**NS2105B** Brass Hammer, Ball Pein



Item No.	Size (lb)	L (mm)	ΔTΔ (g)
NS2105B-1002	1/2	280	230
NS2105B-1004	3/4	280	340
NS2105B-1006	1	280	450
NS2105B-1008	1-1/2	310	680
NS2105B-1010	2	340	910
NS2105B-1012	2-1/2	350	1130

**NS2108A** Brass Hammer, Scaling



Item No.	Size (g)	L (mm)	ΔTΔ (g)
NS2108A-1002	150	280	205
NS2108A-1004	300	280	370

**NS2108B** Brass Hammer, Scaling



Item No.	Size (g)	L (mm)	ΔTΔ (g)
NS2108B-1002	150	330	205
NS2108B-1004	300	350	370

**NS2109** Nylon Hammer



Item No.	Size (g)	L (mm)	ΔTΔ (g)
NS2109-1002	420	280	420
NS2109-1004	650	340	650

**NS2201A** Copper Hammer, Sledge



Item No.	Size (lb)	L (mm)	Weight (g)
NS2201A-1002	1	350	450
NS2201A-1004	2	400	910
NS2201A-1006	3	400	1400
NS2201A-1008	4	450	1800
NS2201A-1010	5	450	2250
NS2201A-1012	6	900	2700
NS2201A-1014	8	900	3600
NS2201A-1016	10	900	4500
NS2201A-1018	12	900	5400
NS2201A-1020	14	900	6400
NS2201A-1022	16	900	7200
NS2201A-1024	20	900	9000

**NS2201B** Copper Hammer, Sledge



Item No.	Size (lb)	L (mm)	Weight (g)
NS2201B-1002	1	350	450
NS2201B-1004	2	400	910
NS2201B-1006	3	400	1400
NS2201B-1008	4	450	1800
NS2201B-1010	5	450	2250
NS2201B-1012	6	900	2700
NS2201B-1014	8	900	3600
NS2201B-1016	10	900	4500
NS2201B-1018	12	900	5400
NS2201B-1020	14	900	6400
NS2201B-1022	16	900	7200
NS2201B-1024	20	900	9000

**NS2203A** Copper Hammer, Drum Type



Item No.	Size (lb)	L (mm)	Weight (g)
NS2203A-1002	1/2	280	230
NS2203A-1004	1	310	450
NS2203A-1006	1-1/2	340	680
NS2203A-1008	2	350	910
NS2203A-1010	3	400	1400
NS2203A-1012	4	400	1800
NS2203A-1014	5	400	2250
NS2203A-1016	6	900	2700
NS2203A-1018	8	900	3600
NS2203A-1020	10	900	4500

**NS2203B** Copper Hammer, Drum Type



Item No.	Size (lb)	L (mm)	Weight (g)
NS2203B-1002	1/2	280	230
NS2203B-1004	1	310	450
NS2203B-1006	1-1/2	340	680
NS2203B-1008	2	350	910
NS2203B-1010	3	400	1400
NS2203B-1012	4	400	1800
NS2203B-1014	5	400	2250
NS2203B-1016	6	900	2700
NS2203B-1018	8	900	3600
NS2203B-1020	10	900	4500

**NS2202A** Copper Hammer, Mallet



Item No.	Size (lb)	L (mm)	Weight (g)
NS2202A-1002	1	350	450
NS2202A-1004	2	400	910
NS2202A-1006	3	400	1400
NS2202A-1008	5	450	2250
NS2202A-1010	6	800	2700
NS2202A-1012	8	900	4500
NS2202A-1014	10	900	5400
NS2202A-1016	15	900	7650

**NS2202B** Copper Hammer, Mallet



Item No.	Size (lb)	L (mm)	Weight (g)
NS2202B-1002	1	350	450
NS2202B-1004	2	400	910
NS2202B-1006	3	400	1400
NS2202B-1008	5	450	2250
NS2202B-1010	6	800	2700
NS2202B-1012	8	900	4500
NS2202B-1014	10	900	5400
NS2202B-1016	15	900	7650

**NS2204A** Brass Hammer, Mallet



Item No.	Size (g)	L (mm)	Weight (g)
NS2204A-1002	500	350	500
NS2204A-1004	1000	400	1000
NS2204A-1006	1500	400	1500
NS2204A-1008	1800	400	1800
NS2204A-1010	2000	400	2000
NS2204A-1012	2700	900	2700
NS2204A-1014	3600	900	3600
NS2204A-1016	4000	900	4000
NS2204A-1018	5000	900	5000

**NS2404B** Brass Hammer, Mallet



Item No.	Size (g)	L (mm)	Weight (g)
NS2204B-1002	500	350	500
NS2204B-1004	1000	400	1000
NS2204B-1006	1500	400	1500
NS2204B-1008	1800	400	1800
NS2204B-1010	2000	400	2000
NS2204B-1012	2700	900	2700
NS2204B-1014	3600	900	3600
NS2204B-1016	4000	900	4000
NS2204B-1018	5000	900	5000

**NS2205A** Copper Hammer, Ball Pein



Item No.	Size (lb)	L (mm)	Weight (g)
NS2205A-1002	1/2	280	230
NS2205A-1004	3/4	280	340
NS2205A-1006	1	280	450
NS2205A-1008	1-1/2	310	680
NS2205A-1010	2	340	910
NS2205A-1012	2-1/2	350	1130

**NS2205B** Copper Hammer, Ball Pein



Item No.	Size (lb)	L (mm)	Weight (g)
NS2205B-1002	1/2	280	230
NS2205B-1004	3/4	280	340
NS2205B-1006	1	280	450
NS2205B-1008	1-1/2	310	680
NS2205B-1010	2	340	910
NS2205B-1012	2-1/2	350	1130





**NS2606A** Copper Hammer, Double face



Item No.	Size (g)	L (mm)	⚖️ (g)
NS2206A-1002	500	350	500
NS2206A-1004	1000	400	1000
NS2206A-1006	2000	400	2000
NS2206A-1008	3000	900	3000
NS2206A-1010	5000	900	5000

**NS2206B** Copper Hammer, Double face



Item No.	Size (g)	L (mm)	⚖️ (g)
NS2206B-1002	500	350	500
NS2206B-1004	1000	400	1000
NS2206B-1006	2000	400	2000
NS2206B-1008	3000	900	3000
NS2206B-1010	5000	900	5000

**NS2207A** Copper Flat Hammer (Euro Type)



Item No.	Size (lb)	L (mm)	⚖️ (g)
NS2207A-1002	1	350	450
NS2207A-1004	2	400	910
NS2207A-1006	3	400	1400
NS2207A-1008	5	450	2250
NS2207A-1010	6	900	2700
NS2207A-1012	8	900	4500
NS2207A-1014	10	900	5400
NS2207A-1016	15	900	7650

**NS2207B** Copper Flat Hammer (Euro Type)



Item No.	Size (lb)	L (mm)	⚖️ (g)
NS2207B-1002	1	350	450
NS2207B-1004	2	400	910
NS2207B-1006	3	400	1400
NS2207B-1008	5	450	2250
NS2207B-1010	6	900	2700
NS2207B-1012	8	900	4500
NS2207B-1014	10	900	5400
NS2207B-1016	15	900	7650

**NS2208A** Copper Hammer, Scaling



Item No.	Size (g)	L (mm)	⚖️ (g)
NS2208A-1002	150	330	205
NS2208A-1004	300	350	370

**NS2208B** Copper Hammer, Scaling



Item No.	Size (g)	L (mm)	⚖️ (g)
NS2208B-1002	150	330	205
NS2208B-1004	300	350	370

NON-SPARKING TOOLS  
NON-MAGNETIC TOOLS

CORROSION RESISTANT TOOLS

## Classification of the zones by explosion risks

ATEX Feasibili	high	average-low	very-low
Gas, Mists or Vapor	<p><b>Zone 0</b> An atmosphere where a mixture of air and flammable substances in the form of gas, vapor or mist is present frequently or continuously or for a long period!</p>	<p><b>Zone 1</b> An atmosphere where a mixture of air and flammable substances in the form of gas, vapor or mist is likely to occur in normal operation occasional</p>	<p><b>Zone 2</b> An atmosphere where a mixture of air and flammable substances in the form of gas, vapor or mist is not likely to occur in normal operation but if it does occur, it will persist for only a short period</p>
Dusts	<p><b>Zone 20</b> An atmosphere where a cloud of combustible dust in the air is present frequently or continuously or for a long period!</p>	<p><b>Zone 21</b> An atmosphere where a cloud of combustible dust in the air is likely to occur in normal operation occasional</p>	<p><b>Zone 22</b> An atmosphere where a cloud of combustible dust in the air is not likely to occur in normal operation but if it does occur, it will persist for only a short period</p>

ADAM TOOLS, SINCE 1987 .  
WWW.ADAM1987.COM  
MOB: 86 17665391446  
EMAIL: BRUCE@ADAM1987.COM